

BEOPLAY V1

BeoPlay V1-32

BeoPlay V1-40



Dear Customer

This Getting Started contains information about the setting up and daily use of your B&O PLAY product and connected equipment.

Your television offers more features and functions than described in this Getting Started. Among other things; Sleep Timers, pin code system and network settings. These and other features are described in more detail in the product's online guide or in the help texts in the television menus.

The guides are found on www.beoplay.com/v1/support.

The guides and the on-screen help texts are also kept up to date if new software introduces new or modified features and functions in your television.

On www.beoplay.com/v1 you can also find more information and relevant FAQs (Frequently Asked Questions) about your product.

Your retailer is your first stop for all your service queries.

Technical specifications, features and the use thereof are subject to change without notice.

WARNING: To reduce the risk of fire or electric shock, do not expose this appliance to rain or moisture.



The lightning flash with arrowhead symbol within an equilateral triangle, is intended to alert the user to the presence of uninsulated “dangerous voltage” within the product’s enclosure that may be of sufficient magnitude to constitute a risk of electric shock to persons.



The exclamation point within an equilateral triangle is intended to alert the user to the presence of important operating and maintenance (servicing) instructions in the literature accompanying the product.

Read these instructions.

Keep these instructions.

Heed all warnings.

Follow all instructions.

Do not use this apparatus near water.

Clean only with dry cloth.

Do not block any ventilation openings. Install in accordance with the manufacturer’s instructions.

Do not install near any heat sources such as radiators, heat registers, stoves, or other apparatus (including amplifiers) that produce heat.

Do not defeat the safety purpose of the polarized or grounding-type plug. A polarized plug has two blades with one wider than the other. A grounding type plug has two blades and a third grounding prong. The wide blade or the third prong are provided for your safety. If the provided plug does not fit into your outlet, consult an electrician for replacement of the obsolete outlet.

Protect the power cord from being walked on or pinched particularly at plugs, convenience receptacles, and the point where they exit from the apparatus.

Only use attachments/accessories specified by the manufacturer.



Use only with the cart, stand, tripod, bracket, or table specified by the manufacturer, or sold with the apparatus. When a cart is used, use caution when moving the cart/apparatus combination to avoid injury from tip-over.

Unplug this apparatus during lightning storms or when unused for long periods of time.

Refer all servicing to qualified service personnel. Servicing is required when the apparatus has been damaged in any way, such as power-supply cord or plug is damaged, liquid has been spilled or objects have fallen into the apparatus, the apparatus has been exposed to rain or moisture, does not operate normally, or has been dropped.

Cautions

- Ensure that the television is positioned, set up and connected in accordance with the instructions in this Getting Started. To prevent injury, use Bang & Olufsen approved stands and wall brackets only!
- Place your television on a firm, stable surface.
- Do not place any items on top of your television.
- Do not subject the television to rain, high humidity or sources of heat.
- The television is intended for indoor use in dry, domestic environments only. Use within a temperature range of 10–40°C (50–105°F).
- If the television has been exposed to temperatures below 5°C (40°F), leave it at room temperature and wait until the television has regained normal room temperature before it is connected to the mains and switched on.
- Do not place the television in direct sunlight or direct artificial light, such as a spotlight, as this may reduce the sensitivity of the remote control receiver. Also if the screen is overheated, black spots may appear in the picture. These spots disappear again, once the television cools down to normal temperature.
- Leave enough space around the television for adequate ventilation.
- No naked flame sources, such as lighted candles should be placed on the apparatus.
- To prevent the spread of fire, keep candles or other open flames away from this product at all times.
- Do not attempt to open the television. Leave such operations to qualified service personnel.
- Do not strike the glass with hard or pointed items.
- The television can only be switched off completely by disconnecting it from the mains socket. The mains socket must always be accessible.
- Follow instructions to ensure correct and safe installation and interconnection of equipment in multimedia systems.
- The product label is placed behind the connection cover.

Contents

Setting up

- 6 How to set up your television
- 8 Connection panel – BeoPlay V1–32
- 10 Connection panel – BeoPlay V1–40

Daily use

- 12 How to use your remote control
- 13 How to navigate in menus
- 15 Watch television
- 16 Media browser
- 17 Change picture or sound settings
- 18 Cleaning
- 19 How do I ...

How to set up your television

Guides and more information, for example, FAQs (Frequently Asked Questions) are found on www.beoplay.com/v1.

1. Unpack the television

Unpack the television and place it on a soft blanket. Remove the four pins from the television.

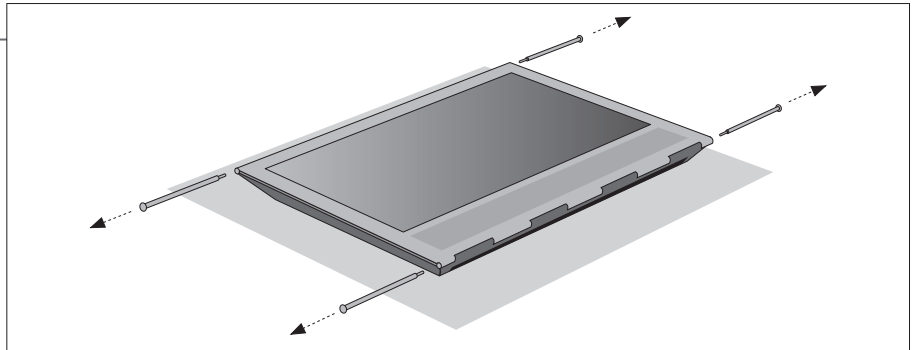

2. Insert speaker cover and mount stand/wall bracket

Before mounting the stand or wall bracket, remember to insert the speaker cover. Hold the speaker cover with both hands and slide it carefully into the hole on the side of the television.

Then mount the stand or wall bracket (see separate guide).

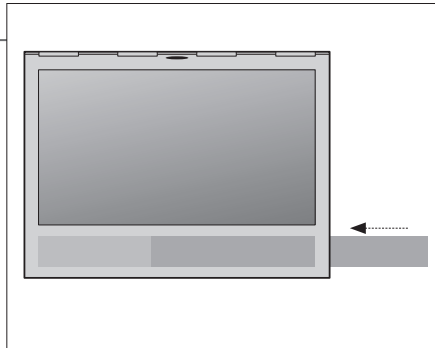

To remove the speaker cover, gently push it out using one of the four pins removed from the television. If the television is mounted on the table stand or wall bracket, you must first remove the sides on the stand or wall bracket to remove the speaker cover. See the guides enclosed with the stand or wall bracket.

3. Connect your TV

- To remove the connection cover, pull out at the bottom first to release the cover, then pull it off.
- Connect the mains cord and Ethernet cable. For a wireless connection, connect the wireless network antenna.
- Switch on the television (press TV). If prompted for a pin code, enter the pin code provided by your retailer and continue with first-time setup (see next page).

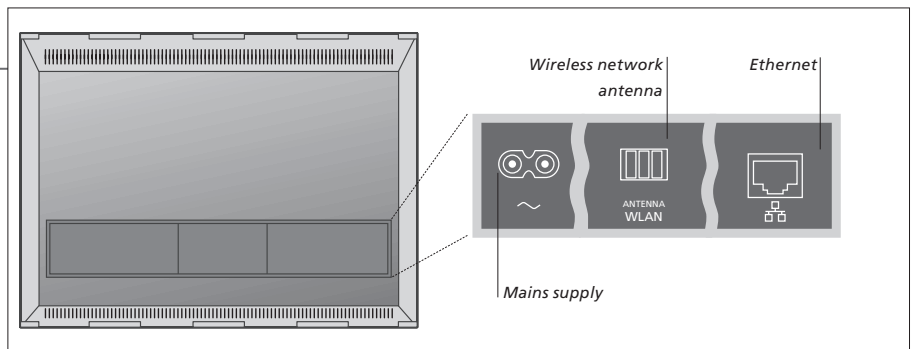

Important – guides and FAQs are found on www.beoplay.com/v1/support

Ventilation To ensure proper ventilation, allow enough space around the screen. Do not cover the ventilation grill. At overheating (flashing standby indicator and an on-screen warning), switch the TV to standby, not off, in order for the TV to cool down. You cannot operate the TV during this time.

Ethernet connection Connect your television to the Internet to receive software updates and download Peripheral Unit Controller (PUC) tables. It is recommended that you set the television to update software automatically.

Network settings For more information on wired or wireless setups, see the online guide and the guide enclosed with the wireless network antenna.

For information on your Beo4 remote control, see page 12 or your Beo4 guide.

4. First-time setup

You will be guided through a number of menus where you must make different settings. Use the Beo4 navigation button \leftarrow , \rightarrow , \uparrow and \downarrow , and press in the middle to select settings. In some submenus, press **BACK** to return to first-time setup.

You can change the settings again later if you wish. If you receive your TV signal via a set-top box, select **DONE** in **SOURCE LIST SETUP**. Set up your set-top box as illustrated below.

MENU LANGUAGE
SOFTWARE UPDATE (USB)
COUNTRY
NETWORK SETTINGS
SOFTWARE UPDATE (INTERNET)
SPEAKER SETUP
SOURCE LIST SETUP
NICE TO KNOW

Follow on-screen instructions. When available, press the **blue** button for help texts.

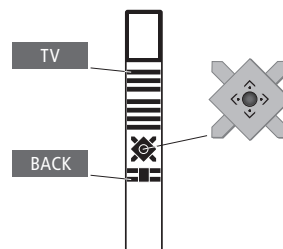

5. Connect external equipment

The illustration here is only one example of many possible setups. When you connect external equipment, for example a set-top box, to the HDMI IN socket on the television (see next pages), you are prompted to configure the source. Follow on-screen instructions.

For information on other setup options, PUC tables and IR-transmitters, see the online guide available on www.beoplay.com/v1support.

It is possible to control non-Bang & Olufsen equipment using the Beo4 remote control with Peripheral Unit Controller (PUC) table. For PUC to work, an IR-transmitter has to be placed close to the IR-receiver on the connected equipment. Check the IR-signal before attaching the IR-transmitter.

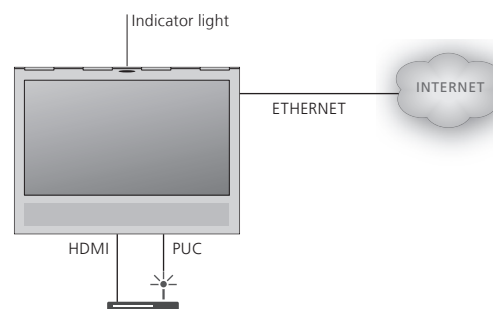

6. Run cables

You can fasten the cables to either sides or in the middle, depending on stand or wall bracket placement. For safety reasons, secure the cables with the enclosed cable ties.

When you have made all the connections, mount the connection cover.

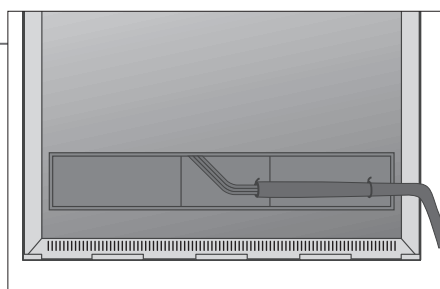

If you have a wall bracket, make sure that there is enough slack in the cables to allow the TV to turn before you fasten the cables with cable ties to make a neat bundle.

- Indicator light – Green** The indicator light flashes green shortly and the TV is ready to be used. To reduce start up time, see the online guide regarding power settings.
- Solid red** The TV is in standby but leave it connected to the mains supply due to software downloads.
- Slowly flashing red** The TV has been disconnected from the mains supply and you must enter the pin code. See the online guide for more information on the pin code system, available on www.beoplay.com/v1support.
- Quickly flashing red** Do not disconnect the TV from the mains supply. Could be due to new software being activated or too many failed pin code attempts.
- Off** The TV is in standby and you can disconnect it from the mains supply if you want. However, this activates the pin code system.

Connection panel – BeoPlay V1–32

Any equipment you connect to the connection panel must be registered in the SOURCE LIST SETUP menu.

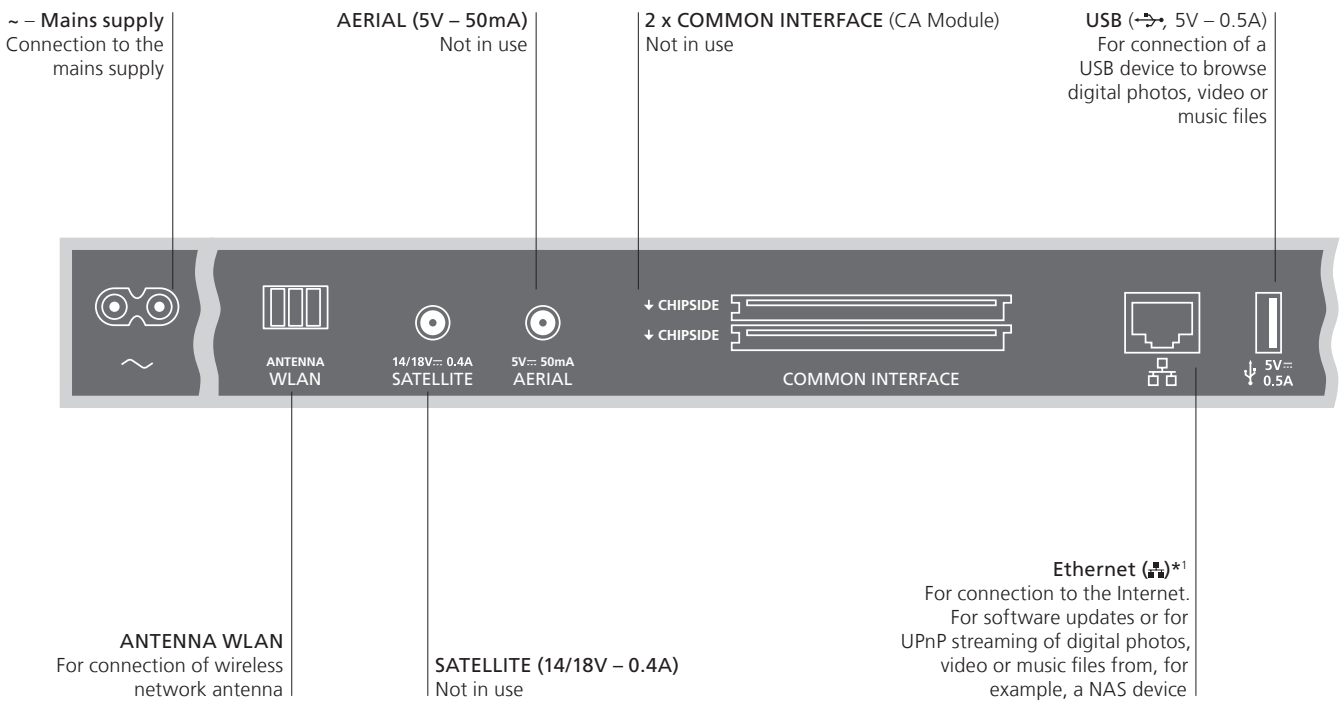

Important

Mains cord and plug Connect the ~ socket on the connection panel of your TV to the wall outlet. The TV is in standby mode and ready to be used. The supplied plug and mains cord are specially designed for the product. Do not change the plug and if the mains cord is damaged, you must buy a Bang & Olufsen approved mains cord.

^{1*}Make sure the cable connection between the product and the router does not exit the building to avoid contact with high voltage.

We recommend that you connect the television to the Internet to be able to receive software updates and to download Peripheral Unit Controller (PUC) tables. PUC tables enable you to operate connected non-Bang & Olufsen products with the Beo4 remote control with navigation button.

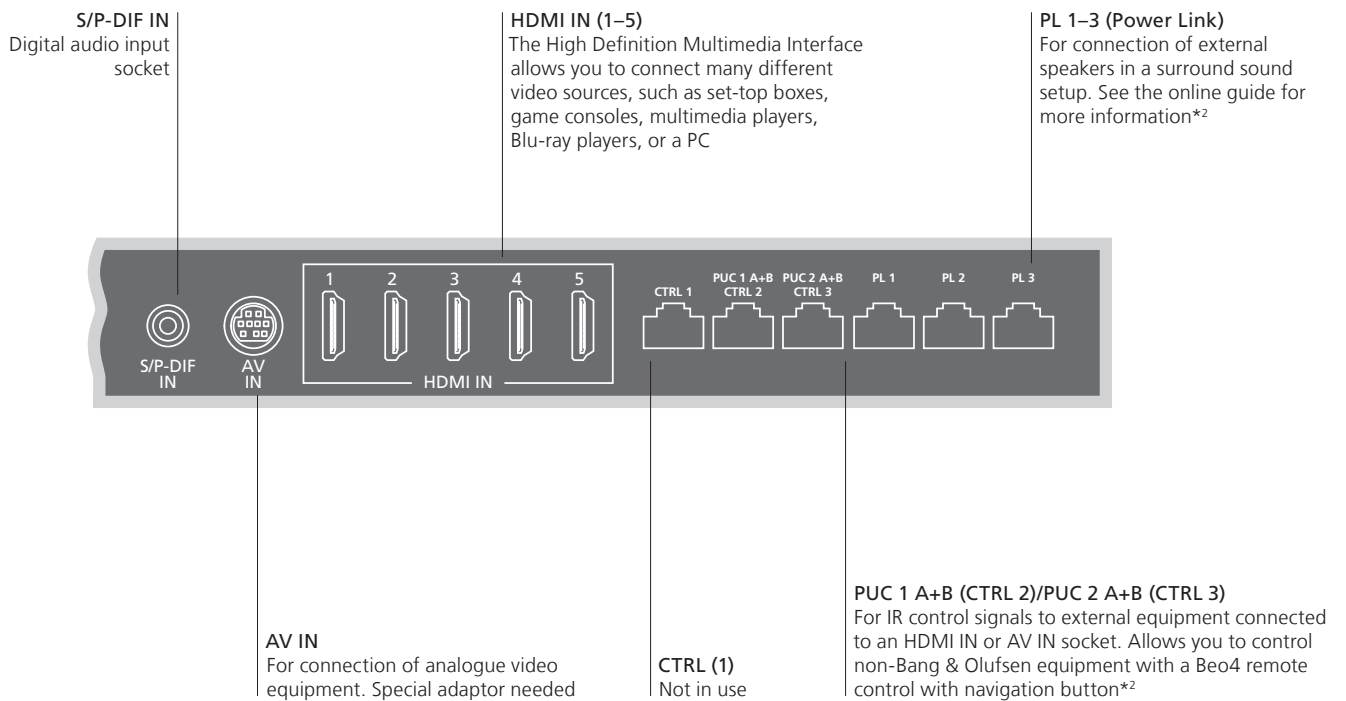

- Cables and adaptors** Depending on the type of equipment you connect to the television, different cables and maybe also adaptors are needed. Cables and adaptors are available from your Bang & Olufsen retailer.
- Ethernet connection** Connect your television to the Internet to receive software updates and download Peripheral Unit Controller (PUC) tables. It is recommended that you set the television to update software automatically.
- *Online guide** The online guide includes more information about setup and connection of external equipment.

Connection panel – BeoPlay V1–40

Any equipment you connect to the connection panel must be registered in the SOURCE LIST SETUP menu.

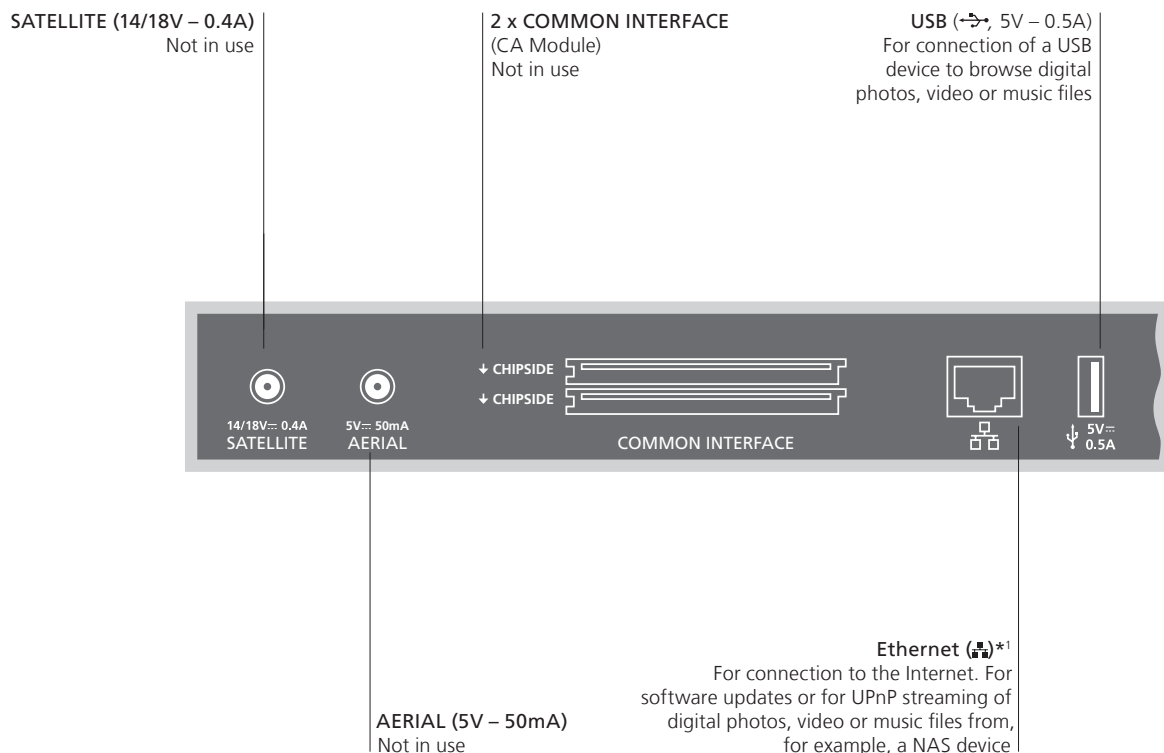

Important

Mains cord and plug Connect the ~ socket on the connection panel of your TV to the wall outlet. The TV is in standby mode and ready to be used. The supplied plug and mains cord are specially designed for the product. Do not change the plug and if the mains cord is damaged, you must buy a new one from your Bang & Olufsen retailer.

*1*Make sure the cable connection between the product and the router does not exit the building to avoid contact with high voltage.

We recommend that you connect the television to the Internet to be able to receive software updates and to download Peripheral Unit Controller (PUC) tables. PUC tables enable you to operate connected non-Bang & Olufsen products with the Beo4 remote control with navigation button.

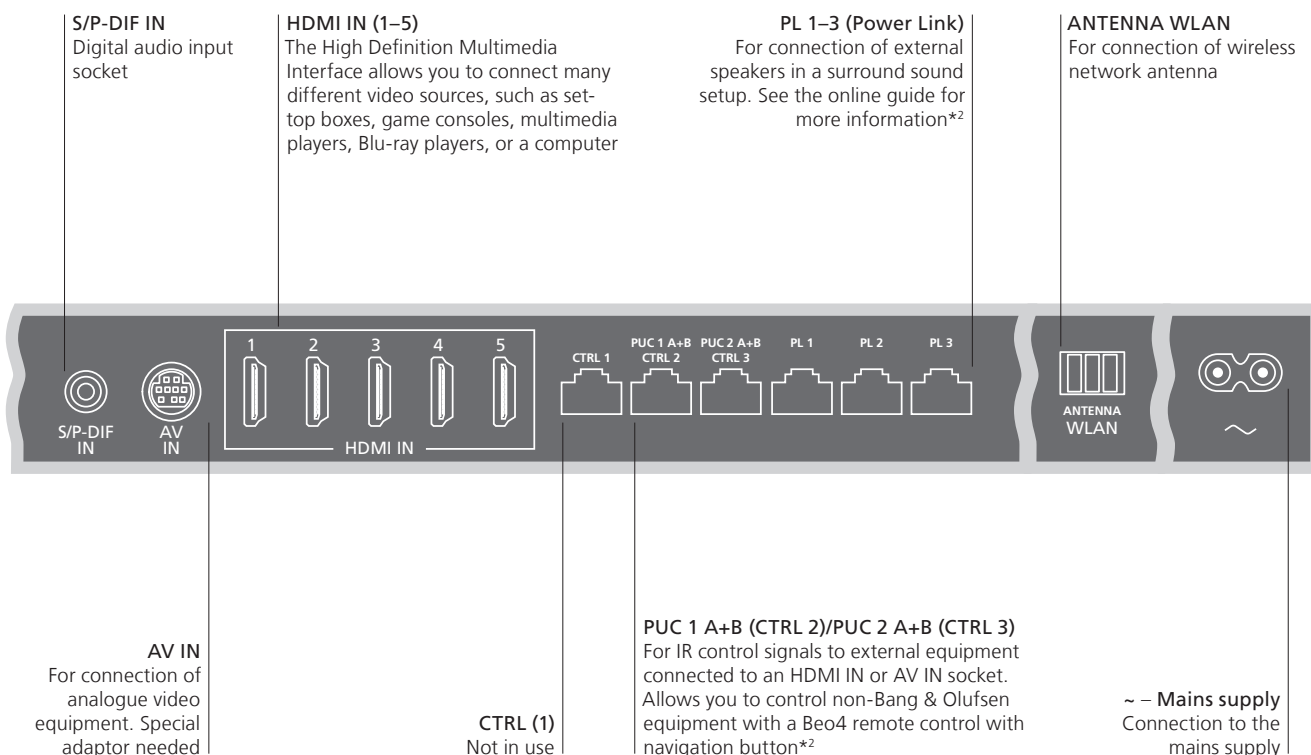

Cables and adaptors

Depending on the type of equipment you connect to the television, different cables and maybe also adaptors are needed. Cables and adaptors are available from your Bang & Olufsen retailer.

Ethernet connection

Connect your television to the Internet to receive software updates and download Peripheral Unit Controller (PUC) tables. It is recommended that you set the television to update software automatically.

²*Online guide

The online guide includes more information about setup and connection of external equipment.

How to use your remote control

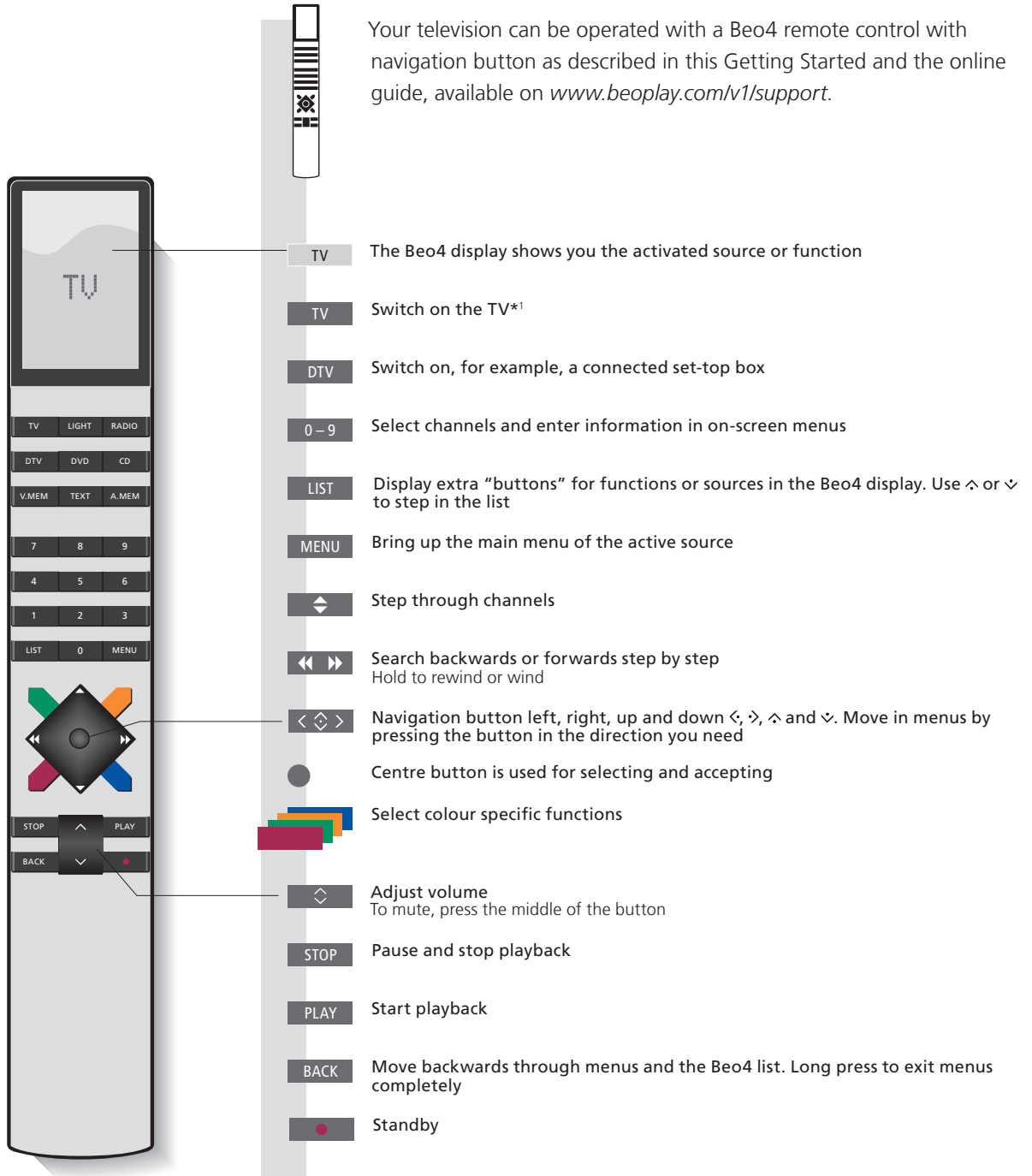

Important – guides and FAQs are found on www.beoplay.com/v1/support

***Beo4 buttons** Some buttons can be reconfigured during the setup process. See the online guide for more information. NOTE! For general information about remote control operation, see the guide enclosed with your remote control.

MODE settings Check that your Beo4 remote control is in **MODE 1**. See page 19 on how to set up your Beo4.

Navigate in menus and select settings using your remote control.

Display and menus

Select source and adjust settings.

TV or V.MEM MENU
 Switch on TV Switch on connected equipment Show menu*¹

Navigate in menus

When a menu is on the screen, you can move between menu options, reveal settings or enter data.

< > 0-9 ●  BACK or BACK
 Highlight menu /change setting Enter data Bring up sub-menu/store setting Select option Move backwards through menus Press and hold to exit menus

Step between menu pages

Some menus take up more space than available on the television screen. This is indicated by half a menu item at the bottom or top of the screen. To easily step from the top of a list to the bottom, use the navigation button up.

<> ◇
 Step in pages Scroll through menu items

A solid line indicates that selection must be made using the **centre** button



A gradient line indicates that you can edit settings using the navigation button left and right

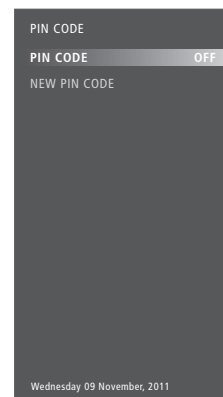

Example of channel list.

Information

- *Main menu** You can always bring up the main menu including a menu overlay listing all the special functions for the active source.
- Help texts** In the SETUP menu, you can show/hide help texts using the **blue** button. Some help texts may cover the menu. For some languages, help texts are only available in English.

Select source

You can select a source just by pressing the dedicated button on the remote control, or you can select a source via the menu.

**Bring up help texts**

You can bring up help texts with explanations of features and functions when available in menus and submenus.

General features and functions are also explained in the NICE TO KNOW menu.*¹

**Information**

¹***NICE TO KNOW menu** Access the menu from the SETUP menu. You can read about basic features and functions. When your television receives software updates (requires Internet connection), new features and functions will be explained here.

Choose a TV channel by its number, switch to another channel or adjust the sound volume.

Switch on the TV

 TV
Press, for example, TV

Select a channel

 Select *or*  Select channel  Select previous channel

Bring up and use the menu overlay

You can bring up the main menu including functions for the active source.

 MENU Press *or*  *or*  Activate the desired function

Adjust the volume

 Adjust volume  Press in the middle to mute sound  Press to bring sound back

Information

Programme Guide and information

For information about Programme Guide and information, see the online guide on www.beoplay.com/v1/support.

Media browser

You can play music and video files and browse photos stored either on a storage device or in a product connected via a DLNA/UPnP enabled media server. For more information about connections and functions, see the online guide.

Connect a storage device

When you connect a storage device to your television, it detects the source automatically and asks if you want to browse the content. You can also access the MEDIA BROWSER menu via the SETUP menu.

MEDIA

Bring up MEDIA in your Beo4 display*¹

Listen to your music

Select the folder with the music you wish to listen to.



Select storage device with music



Browse in files or step in tracks. Select a music file to start playback



Pause



Resume playback



Back up through menus or hold to return to the media browser main menu

Browse your photos

Select the folder with the photos you wish to watch.



Select storage device with photos



Browse files and folders and press to start slideshow



Pause



Step between previous and next photo

Playback video files

Select the folder with the video files you wish to watch.



Select storage device with video files



Browse files and folders and press to open



Step minute by minute. Press and hold to cue. Press again to change cue speed



Resume playback

Information

¹*Beo4 LIST

If you do not have the MEDIA button in the Beo4 LIST, you can dedicate another button to the media browser in the SETUP menu. See page 19.

Storage devices

Access MEDIA BROWSER source

You can connect, for example, USB devices and hard disks connected via USB or Ethernet.

You can bring up the main menu, select SOURCE LIST, highlight MEDIA BROWSER, and press the centre button to activate the media browser.

While you watch television, you can adjust the sound and picture settings. See the online guide on www.beoplay.com/v1/support for more information about these settings.

Select sound modes

The television has several sound modes optimised for different types of programmes.

In the SOURCE LIST SETUP menu, you can, for each source, set up a sound mode to be used each time you activate this source.

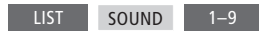

or



Select between sound modes 1–9 if you remember the number of the mode you want*¹

Bring up sound modes on the television screen and select mode*¹

Select picture modes

You can activate different picture modes to use for different types of programmes. When you select a picture mode for a source, it is only saved until you switch off the television or switch to a different source.

In the SOURCE LIST SETUP menu, you can, for each source, set up a picture mode to be used each time you activate this source.



or



Select between picture modes 1–3 if you remember the number of the mode you want*¹

Bring up picture modes on the television screen and select mode*¹

Select picture format

In the SOURCE LIST SETUP menu, you can, for each source, set up a picture format to be used each time you activate this source. You can also select a different picture format temporarily.



or



Select between picture formats 1–3 if you remember the number of the format you want

Bring up picture formats on the television screen and select format

Swap between formats

AUTO (select 1)

To reduce black bars in top and bottom, the picture is scaled without changing the picture geometry. However, if a 4:3 source signals a wrong aspect ratio, the picture will be stretched horizontally

AUTO WIDE (select 2)

To reduce black bars in top and bottom, the picture is scaled and stretched horizontally to fill out as much of the screen as possible

SOURCE FORMAT (select 3)

The source determines the picture format

Information

¹**Beo4 LIST** In order to display SOUND or PICTURE on Beo4, you must first add them to the Beo4 list of functions, see page 19.

Cleaning

Regular maintenance, such as cleaning, is the responsibility of the user. To achieve the best result, follow the instructions below.

Screen

- Wipe dust off the screen using a dry, soft cloth.
- To remove stains or dirt, use a soft, lint-free, firmly wrung cloth and water.
- Never use alcohol or other solvents to clean any parts of the TV.
- Do not strike the screen with hard or pointed items.
- Some micro-fibre cloths may harm the optical coating due to their strong abrasive effect.

Cabinet

- Wipe dust off the surfaces using a dry, soft cloth.
- To remove stains or dirt, use a soft, lint-free, firmly wrung cloth and a solution of water and mild detergent, such as washing-up liquid.
- Never use alcohol or other solvents to clean any parts of the TV.

Speakers

- Avoid spraying liquid directly on the screen as this may damage the speakers.
- The speakers may be cleaned with a vacuum cleaner with a brush nozzle, and set to the lowest suction level.
- To remove the speaker cover, gently push it out using one of the four pins removed from the television. When the television is mounted on the wall bracket or table stand, you must first remove the sides on the stand or wall bracket to remove the speaker cover. See guide enclosed with the stand or wall bracket.

For more information on your Beo4 remote control, see the Beo4 guide.

... add a new 'button' to my Beo4 list?

To activate some functions on your Beo4 remote control, you must first add the 'button' to the Beo4 list of functions.

- > Press and hold the standby button down.
- > Press **LIST** to get access to the Beo4 setup function.
- > Let go of both buttons. ADD? appears in the display.
- > Press the centre button and use the navigation button up to select, for example, AV?
- > Press the **centre** button to bring up the list of extra 'buttons' to add from. The first 'button' appears in the display, it flashes on and off.
- > Press the navigation button up and down to move forwards or backwards in the list of extra 'buttons'.
- > Press the **centre** button to add and place the 'button' on its preset position in the list, or ...
- > ... press **1 – 9** to insert the 'button' at a specific position in the list.
- > ADDED appears, indicating that the 'button' has been added. Long press on **BACK** will leave the setup.

... select another Beo4 button to activate a source?

If you want another Beo4 button to activate a source, you can change this in the SOURCE LIST SETUP menu.

- > Press **MENU** and bring up the SETUP menu.
- > Bring up the SOURCE LIST menu.
- > Select the source you want to configure, for example MEDIA BROWSER, and press the **centre** button.
- > Step to the BUTTON menu and use the navigation button right to bring up the list of buttons.
- > Use the navigation button up and down to step between the buttons and press the **centre** button to select the button you want to use.

... set my Beo4 in MODE 1?

A Beo4 remote control with navigation button must be set to MODE 1.

- > Press and hold the standby button down.
- > Press **LIST** to get access to the Beo4 setup function.
- > Let go of both buttons. ADD? appears in the display.
- > Press **LIST** or navigation button up to display **MODE?** on Beo4.
- > Press the **centre** button to select the setup you want.
- > Press the navigation button up and down to display **MODE 1** on Beo4.
- > Press the **centre** button to store the configuration.
- > STORED appears, indicating that the configuration has been stored. Long press on **BACK** will leave the setup.

Waste Electrical and Electronic Equipment (WEEE) – Environmental protection



Electrical and electronic equipment, parts and batteries marked with this symbol must not be disposed of with normal household wastage; all electrical and electronic equipment, parts and batteries must be collected and disposed of separately.

When disposing of electrical and electronic equipment and batteries by use of the collection systems available in your country, you protect the environment, human health and contribute to the prudent and rational use of natural resources.

Collecting electrical and electronic equipment, batteries and waste prevents the potential contamination of nature with the hazardous substances which may be present in electrical and electronic products and equipment.

Your Bang & Olufsen retailer will advise you of the correct way of disposal in your country.

This product complies with applicable environmental legislation throughout the world.

This product incorporates copyright protection technology that is protected by U.S. patents and other intellectual property rights. Use of this copyright protection technology must be authorized by Rovi Corporation, and is intended for home and other limited viewing uses only unless otherwise authorized by Rovi Corporation. Reverse engineering or disassembly is prohibited.

HDMI, the HDMI Logo and High-Definition Multimedia Interface are trademarks or registered trademarks of HDMI Licensing LLC.



Manufactured under license from Dolby Laboratories. Dolby and the double-D symbol are trademarks of Dolby Laboratories.



Manufactured under license under U.S. Patent Nos: 5,956,674; 5,974,380; 6,487,535 & other U.S. and worldwide patents issued & pending. DTS, the Symbol, & DTS and the Symbol together are registered trademarks & DTS 2.0 Channel is a trademark of DTS, Inc. Product includes software. © DTS, Inc. All Rights Reserved.

For the Canadian market only!

This device complies with Industry Canada licence-exempt RSS standard(s). Operation is subject to the following two conditions:

(1) this device may not cause interference, and
(2) this device must accept any interference, including interference that may cause undesired operation of the device.

Under Industry Canada regulations, this radio transmitter may only operate using an antenna of a type and maximum (or lesser) gain approved for the transmitter by Industry Canada. To reduce potential radio interference to other users, the antenna type and its gain should be so chosen that the equivalent isotropically radiated power (e.i.r.p.) is not more than that necessary for successful communication.

This radio transmitter (IC ID: 3775B-LBWA1ZZPD) has been approved by Industry Canada to operate with the antenna types listed below with the maximum permissible gain and required antenna impedance for each antenna type indicated. Antenna types not included in this list, having a gain greater than the maximum gain indicated for that type, are strictly prohibited for use with this device.

Antenna list:

TYCO 1513712-1; Linear; Gain 2.4 GHz: 0 dBi, 5 GHz: 3 dBi; Impedance 50 ohm.

Please note that high-power radars are allocated as primary users (i.e. priority users) of the bands 5250-5350 MHz and 5650-5850 MHz and these radars can cause interference and/or damage to LE-LAN (License-exempt Local Area Network) devices.

This equipment complies with IC RSS-102 radiation exposure limits set forth for an uncontrolled environment. This equipment should be installed and operated with minimum distance 20 cm between the antenna and your body.

For the US-market only!

Changes or modifications not expressly approved by the party responsible for compliance could void the user's authority to operate the equipment.

This device complies with part 15 of the FCC Rules. Operation is subject to the condition that this device does not cause harmful interference.



351101812010007

