

BEOSOUND LEVEL WALL BRACKET

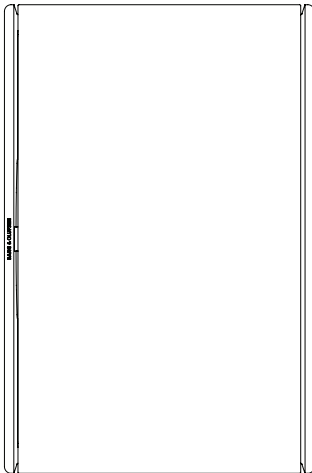

BANG & OLUFSEN

1

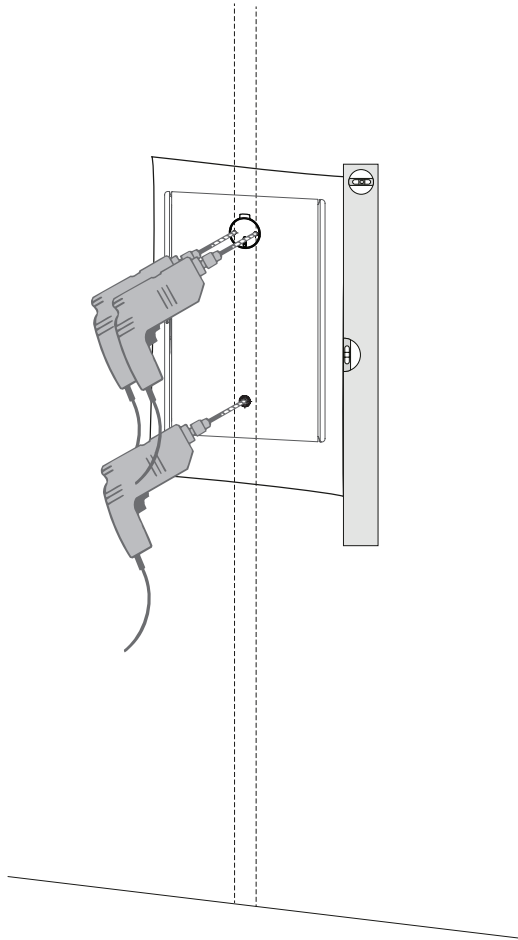

2

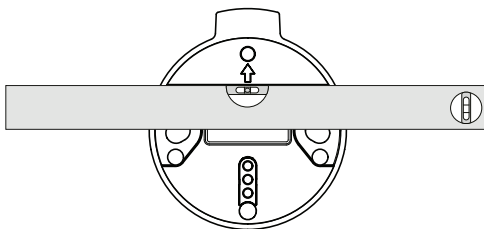
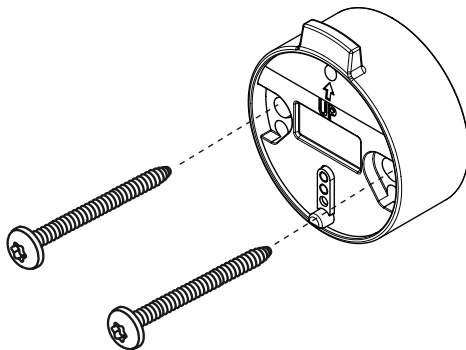

Use the correct size and type of screws and wall anchors ($\text{Ø}3\text{-}\text{Ø}4$) - taking into account the construction and condition of the wall.

3

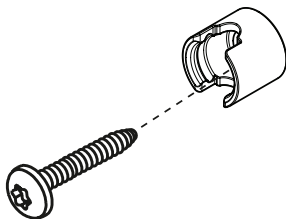

4

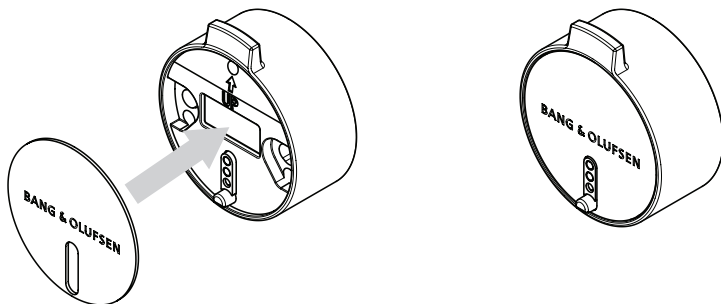

5

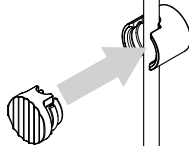
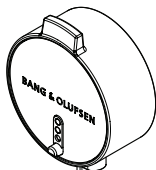

6

A

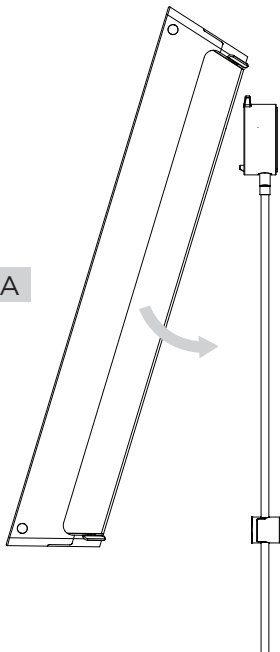

B

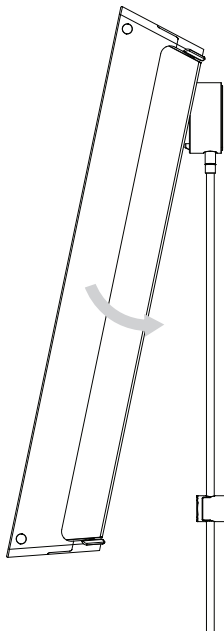

C

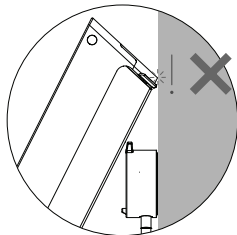
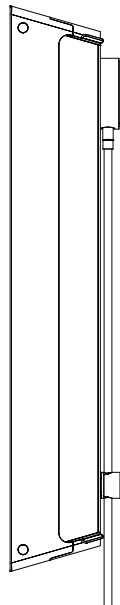

7

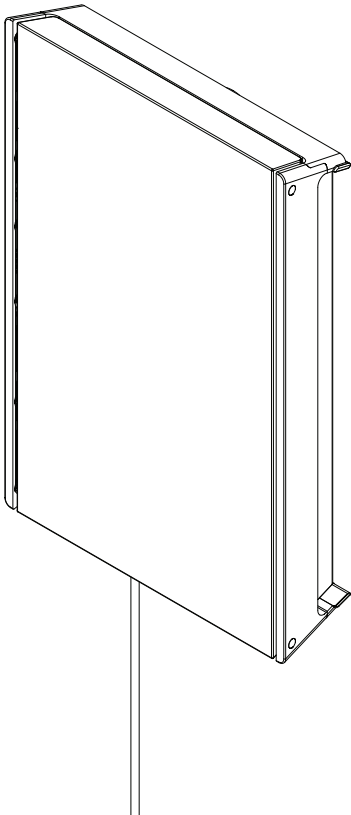

1

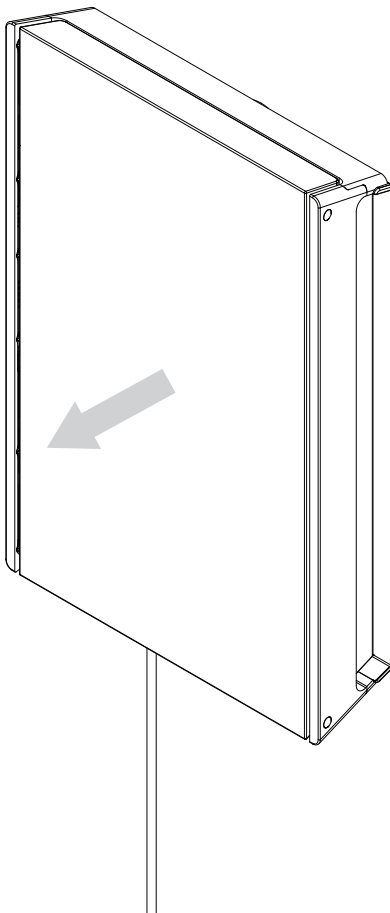

II

