

BeoSound 4

Guide

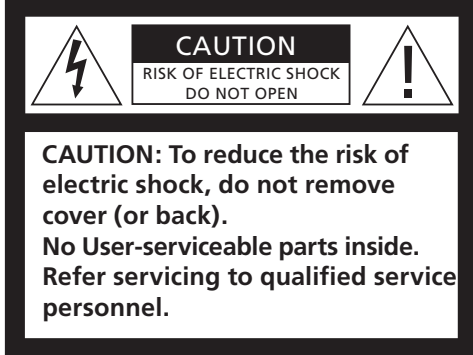

WARNING: To reduce the risk of fire or electric shock, do not expose this appliance to rain or moisture. Do not expose this equipment to dripping or splashing and ensure that no objects filled with liquids, such as vases, are placed on the equipment.

To completely disconnect this equipment from the AC Mains, disconnect the power supply cord plug from the AC receptacle.



The lightning flash with arrowhead symbol within an equilateral triangle, is intended to alert the user to the presence of un-insulated "dangerous voltage" within the product's enclosure that may be of sufficient magnitude to constitute a risk of electric shock to persons.



The exclamation point within an equilateral triangle is intended to alert the user to the presence of important operating and maintenance (servicing) instructions in the literature accompanying the product.

Contents

Introducing your music system, 4

Menu system, 5

How to use your music system, 6

Find out how to switch on and operate sources, such as CD, radio or A.MEM via the close-up operation panel

How to read the menu symbols, 8

Get an explanation to the symbols which appear in the menus

How to use the menus, 9

Find out how to move around in menus and how to make settings in fill-in menus

Naming procedure, 10

Find out how to name your radio stations, CDs, folders or Timers

First-time setup, 11

Find out about the first-time setup procedure

Call up additional sources, functions and menus, 12

See which functions, features and menus can be activated via the close-up operation panel

A.MEM and memory card, 13

Find out how to use the source A.MEM

Tune in and edit radio stations, 14

Find out how to tune in, move, name and delete radio stations

Audio CD settings, 16

Find out how to activate special CD playback functions, how to name CDs

Make sound settings, 17

Find out how to set your own preferences for volume, bass, treble, balance and loudness

Make option settings, 18

Find out how to change the basic settings of your music system

Make your music system start and stop automatically, 19

Find out how to name and activate Timers

How to use the pincode system, 20

Find out how to activate and use the pincode system

Use the Beo4 remote control, 21

Find out how to use the Beo4 remote control and operate your music system from a distance

Setting-up and assembly, 22

Find out how to set up your music system and mount the glass door

Connect the cables, 24

Find out how to connect speakers and auxiliary equipment

Audio/Video setup, 26

Find out how to connect your music system to your video system

Maintenance, 27

Find out how to clean your music system

Index, 28

Move your hand from side to side under the operation panel and the glass door opens automatically, revealing the operation panel behind the door. Press the LOAD button and the glass door slides completely open, enabling you to load a CD.

Use your music system to listen to A.MEM or radio, to play a single CD or to record onto the memory card.

Introducing your music system

Display

The extended status display is not switched on permanently. Only the first line is displayed all the time. When you operate the music system, the display shows additional information, such as track time and CD name briefly. If you change the display setting to EXTENDED, the display always shows current status and additional information. For further information, see page 18.

Indicator light ...

The indicator light below the display shines continuously when the music system is in standby. The light flashes when pincode protection is active and you must enter a pincode to activate the system.

Load a CD ...

Press the LOAD button to raise the clamp which holds the CD in place.

You can now remove a CD or load one you want to play. Always load a CD with the label facing up.

Press LOAD again to lower the clamp. If you press CD, the clamp lowers automatically and playback begin.



Socket for headphones

When headphones are plugged in, the speakers, connected to your music system, are muted.

Headphones socket

Menu system overview

How to use your music system

- 1 N.MUSIC
- 2 N.RADIO
- 3 A.AUX
- 4 RANDOM ON/OFF
- 5 REPEAT ON/OFF
- 6 TIMER ON/OFF
- 7 EDIT A.MEM
 - 1 ARRANGE
 - REARRANGE
 - DELETE TRACK
 - DELETE FOLDER
 - 2 RENAME
- 8 PLAY TIMER
 - 1 TIMER 1 PROGRAMMING
 - ON/OFF
 - SOURCE (SOURCE, PROGRAM)
 - START/STOP
 - DAYS
 - NAME
 - 2 TIMER 2
 - 3 TIMER 3 ...
- 9 SHOW CLOCK
- PIN CODE SETUP
 - 1 NEW PINCODE
 - 2 DELETE PINCODE
- FIRST TIME SETUP
- 10 SETUP
 - 1 A.MEM
 - 1 EDIT A.MEM
 - 2 FORMAT MEMORY CARD
 - 3 COPY PROTECTION
 - 2 RADIO
 - 1 AUTO TUNING
 - 2 DAB ONLY AUTO TUNING
 - 3 ARRANGE PROGRAMS
 - DELETE ALL PROGRAMS
 - REARRANGE
 - 4 ADD PROGRAM
 - TUNE (BAND, FM ...)
 - NAME PROGRAM
 - 5 EDIT PROGRAM
 - TUNE (BAND, FM ...)
 - NAME PROGRAM
 - 6 DAB AERIAL ADJUSTMENT
 - 7 DAB DRC
 - 3 NAME CD
 - 4 SOUND
 - 5 OPTIONS
 - 1 SET CLOCK
 - 2 TIMER ON/OFF
 - 3 SELECT LANGUAGE
 - 4 DISPLAY SETUP
 - 5 MENU OPTIONS

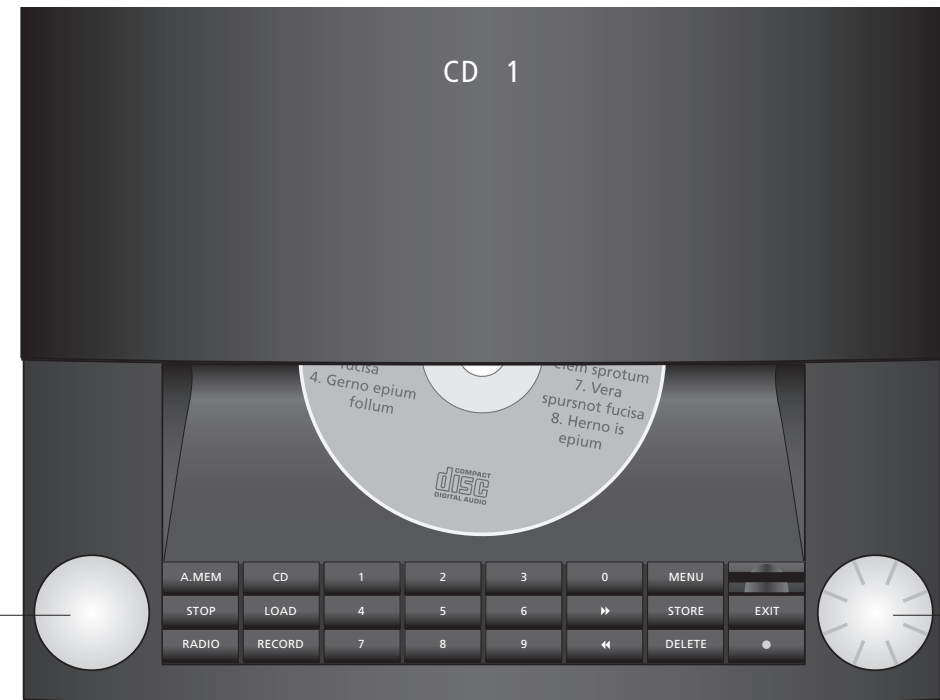

Volume adjustment
Slide your finger around the volume 'wheel' to adjust volume. Press to mute sound, press again to recall sound.

Navigation wheel
Turn the 'navigation wheel' to move the cursor etc., press the wheel for GO - refer to the next page for further instructions.

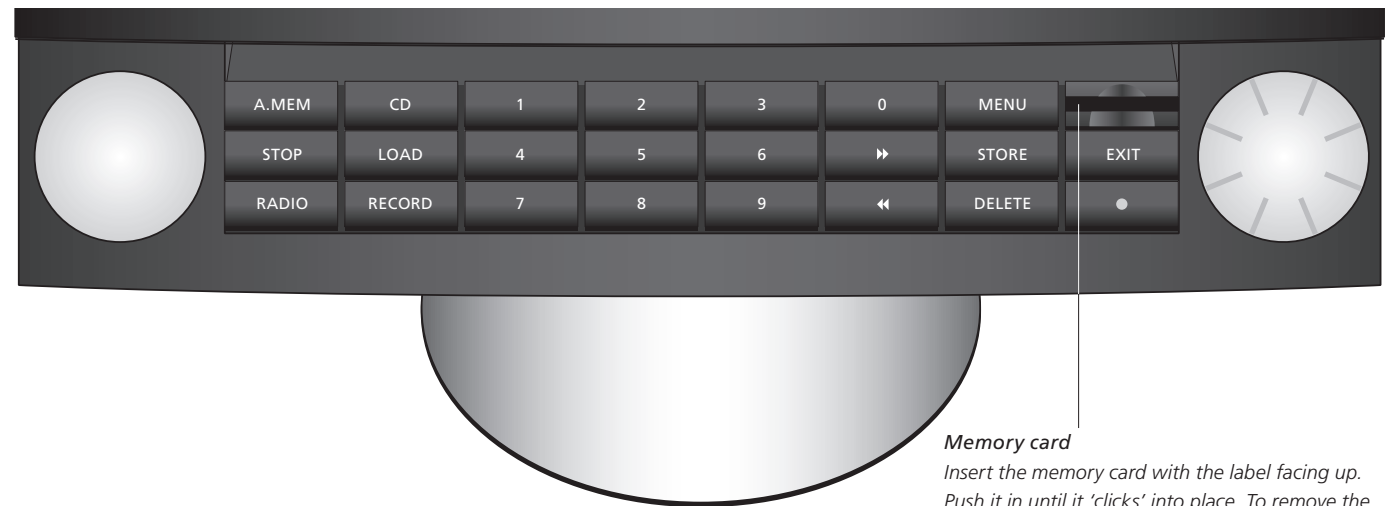

Memory card
Insert the memory card with the label facing up. Push it in until it 'clicks' into place. To remove the card, push in to release, then pull out.

A.MEM

Activates A.MEM and starts playback of an inserted memory card.

CD

Starts playback of a loaded CD.

STOP

Pauses playback. To stop recording, press A.MEM then STOP.

LOAD

Opens and closes the disc compartment.

RADIO

Switches on the radio.

RECORD

When pressed twice, records the playing source (radio, CD or A.AUX) onto the inserted memory card.

0 – 9

Selects radio program numbers, tracks on a CD, folders, or N.MUSIC* tracks, or numbered menus. Enters numbers in menus. Press GO then a number button to select a track in an A.MEM folder.



Searches backwards through a CD, steps backwards between folders in A.MEM or N.MUSIC* mode, and moves the cursor to the left in menus. Steps back one level in the menu system.



Searches forward through a CD, steps forward between folders in A.MEM or N.MUSIC* mode, and moves the cursor to the right in menus.

MENU

Brings up extra sources, functions and menus in the display.

STORE

Stores settings, names, etc. in menus.

EXIT

Exits all menus.

DELETE

Deletes tracks, folders or radio programs. Highlight what you want to delete, then press DELETE twice.

Deletes the last character in the naming menus, press and hold to delete the entire name.



Switches your music system to standby.



Symbol of the navigation wheel – turn the wheel clockwise or counter-clockwise to step between tracks or stations, to move the cursor vertically between menus, and to adjust settings. Moves horizontally between characters in the naming menus.

Press to enter submenus and to accept settings and choices in menus.

When listening to radio, press and hold the wheel to bring up a list of stations in the display. Turn the wheel to move to the station you want, and press the wheel to listen to the chosen station. When listening to A.MEM, press and hold the wheel to bring up a list of folders in the display. Turn the wheel to move to the folder you want, and press the wheel to see the tracks in the chosen folder.

Close-up operation panel

All functions of your music system can easily be operated via the close-up operation panel. An explanation to the buttons is found here.

BeoSound 4 can also be operated with the Beo4 remote control. For further information, refer to page 21.

*NOTE! If your Music system is set up in a Master Link system and a computer with BeoLink PC 2 or BeoPort is connected, you can listen to N.Music or N.Radio via the music system. For further information refer to the BeoLink PC 2 or BeoPort Guide.

How to read the menu symbols

The menus of your music system gives you several options. Choose extra functions and features via the menus or make your own setup preferences.

The current settings for the functions are shown in the menu, for example 'RANDOM – ON or OFF'.

The symbols explained to the right help you find your way around the menus. Use the 'wheel' and arrow buttons to move around the menu system. To enter a fill-in menu, you must press the 'wheel' or the right arrow button.



If your system is set up in a Audio/Video system, some settings must be made on the connected television or a connected radio.

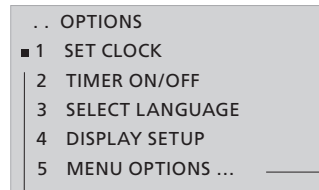

Menu level symbols ...

- One dot in front of a menu indicates that you have moved down one level in the menu system.
- Two dots in front of a menu indicates that you have moved down two levels in the menu system.
- Three dots in front of a menu indicates that you have moved down three or more levels in the menu system.



The square cursor ...

- A square in front of a menu indicates the position of your cursor, to enter the menu or switch a function, such as 'RANDOM', on or off, press the wheel  or press the  button.
- = Two white lines indicate that these particular menus are not available at the moment. You may have to activate a specific source before entering the menus.

- Three dots after a menu name indicate that further submenus are available, to move to the next level, you must press the wheel  or the  button.

How to change a setting ...

Press **MENU** to bring up the menu system

Turn the wheel  to move to SETUP

Press the wheel  to enter the SETUP menu

- 1 N.MUSIC
- 2 N.RADIO
- 3 A.AUX
- 4 RANDOM ON
- 5 REPEAT OFF
- 6 TIMER ON
- 7 EDIT A.MEM
- 8 PLAY TIMER
- 9 SHOW CLOCK
- 10 SETUP ...

Turn the wheel  to move to OPTIONS

Press the wheel  to enter the OPTIONS menu

- 1 A.MEM ...
- 2 RADIO ...
- 3 CD ...
- 4 SOUND ...
- 5 OPTIONS ...

Press the wheel  to enter the SET CLOCK menu

- 1 SET CLOCK
- 2 TIMER ON/OFF
- 3 SELECT LANGUAGE
- 4 DISPLAY SETUP
- 5 MENU OPTIONS ...

Turn the wheel  to set the correct time (or use the number buttons to do so)

Press the wheel or press **▶▶** to move to 'YEAR' and turn the wheel  to set the correct year

Proceed to MONTH and DAY

Press **STORE** to store your settings directly, then STORED appears in the display

Press **EXIT** to leave the menu

... SET CLOCK
 TIME YEAR MONTH DAY
 12:00 2005 SEP 12
 - - - -

Main menus ...

Enters the menu system

MENU

Moves cursor up or down. Press to enter a menu



Backs up through menus



Exits the menus

EXIT

Fill-in menus ...

Adjusts up or down, selects or deselects, and changes settings in menus. Press to accept settings



Moves between settings or moves the cursor in the menus – press **▶▶** to bring up additional information in the display



Stores settings and leaves the fill-in menu

STORE

Exits menus

EXIT

Naming procedure

Use the naming function, for example, to name your Timers for easy recognition, or your CDs. The naming procedure is the same no matter what you are naming.

Each name may contain up to 17 characters, including numbers, however, Timer names can only contain up to 12 characters.

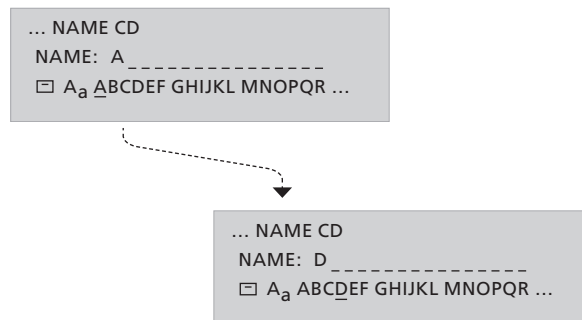

How to use naming menus ...

Navigate ... When you enter a naming menu, a name is suggested and the cursor is placed under the store symbol (□).

Turn the wheel to move between characters and press the wheel to select a character.

Store ... Press STORE to store a name, or move the cursor to the □ symbol and press the wheel to store.

Special characters ... To use special characters move the cursor to the ¶ symbol and press the wheel. To return to ordinary characters, move the cursor to the ¶ symbol and press the wheel.

Large or small letters ... To switch between large and small letters, move the cursor to the A_a symbol and press the wheel.

Delete ... Press DELETE to delete the last character. Press and hold DELETE to delete the entire name.

Numbers ... To enter a number, press a number button.

Once your music system is installed and switched on for the first time, you are guided through the first-time setup procedure. The first time setup consists of:

- Menu language selection
- DAB aerial adjustment*
- Auto tuning of radio stations
- Setting your sound preferences
- Setting the time and date
- Adding to the list of sources and functions which appear in the display when you press MENU
- Setting display preferences

- 1 SELECT LANGUAGE
- 2 DAB AERIAL ADJUSTMENT
- 3 AUTO TUNING
- 4 SOUND
- 5 SET CLOCK
- 6 MENU OPTIONS
- 7 DISPLAY SETUP

What's on the FIRST-TIME SETUP menus ...

(ENTER PINCODE) ... If your retailer has not disabled the factory pincode, you must enter the pincode, you have received from the retailer.

SELECT LANGUAGE ... Select your preferred language for the menus in the display from the list of available languages.

DAB AERIAL ADJUSTMENT* ... Use the indicator to determine the best position for your DAB aerial, refer to page 15 for further instructions.

AUTO TUNING ... Let the music system tune in all available FM and DAB* radio stations for you.

SOUND ... Adjust the sound parameters to your liking.

SET CLOCK ... Set the built-in clock to the correct time and date.

MENU OPTIONS ... Add sources, functions and menus to the list which appears in the display when you press the **MENU** button.

DISPLAY SETUP ... Select the display reading, you prefer for radio, CD, A.MEM and status respectively.

The FIRST-TIME SETUP menus appears automatically when you switch the system on for the first time.

Useful hints ...

To store your settings in a menu and move on to the next menu in the sequence, press **STORE**.

All the settings you make during first-time setup, can be changed via the menus at any time. For further information on the **OPTIONS** menu, refer to page 18.

For information on how to change the pincode or disable the pincode system, refer to page 20.

If your music system is connected to other Bang & Olufsen equipment, you may have to set the clock via the connected equipment.

*NOTE! DAB (Digital Audio Broadcast) radio stations are only available if they are broadcast in your area and your music system is equipped with the built-in DAB module. For further information about tuning DAB stations, refer to the chapter 'Tune in and edit radio stations' on page 14.

Call up additional sources, functions and menus

The options, which appear when you press MENU, are additional sources, functions or menus.

From the factory, the only menu entry available when you press the MENU button is SETUP. To switch on additional sources or create short-cuts to frequently used functions, such as EDIT A.MEM or TIMER, add these sources or functions to the list. This is done via the OPTIONS menu, for further information, refer to page 18.

1	N.MUSIC
2	N.RADIO
3	A.AUX
4	RANDOM [ON/OFF]
5	REPEAT [ON/OFF]
6	TIMER [ON/OFF]
7	EDIT A.MEM
8	PLAY TIMER
9	SHOW CLOCK
10	SETUP
	1 A.MEM
	2 RADIO
	3 CD
	4 SOUND
	5 OPTIONS

Press the MENU button to call up additional sources, functions and menus. The contents of the list depends on what you have added to it.

N.MUSIC ... Select to listen to N.Music*.

N.RADIO ... Select to listen to N.Radio*.

A.AUX ... Select to access equipment connected to the AUX socket. This only activates the AUX socket.

RANDOM (ON/OFF) ... Select to activate or deactivate the random playback function for CD and A.MEM.

REPEAT (ON/OFF) ... Select to activate or deactivate the repeated playback function for CD and A.MEM.

TIMER (ON/OFF) ... Select to activate or deactivate the Timer function.

EDIT A.MEM ... Select to be able to edit the inserted memory card.

PLAY TIMER ... Select to enter or edit timer programmings.

SHOW CLOCK ... Select to bring up the time in the display.

SETUP ... Select to call up the setup menu, for details on the contents of the setup menu, refer to the following pages.

Useful hints ...

You can select a menu by its number, or toggle a function on or off by pressing the appropriate number. If for example the function RANDOM ON/OFF is number 4 in the menu system, press 4 to toggle the function on or off.

If you want RANDOM to be available, add it to the menu options. For further information, refer to page 18.

For further information about special CD playback functions, refer to page 16.

*NOTE! If your BeoSound 4 is set up in a Master Link system and a computer with BeoLink PC 2 or BeoPort connected, you can listen to N.Music or N.Radio via BeoSound 4. For further information refer to the BeoLink PC 2 or BeoPort Guide.

You can either use the memory card as a source in your music system and play back the music on the card, or you can record CDs, radio programmes or from the A.AUX source onto the inserted memory card.

If a memory card is inserted and another source is playing, for example, CD, simply press RECORD twice to start recording onto the card. Time remaining on the card is shown in the display and when the card is full, the display informs you.

There can be up to 250 folders on your memory card and each folder can contain up to 250 tracks. Folders can only be placed in the root of the memory card and tracks must be placed in folders.

We recommend that you format new memory cards in BeoSound 4 before recording onto them. Only MultiMedia (MMC) and Secure Digital (SD) cards from SanDisk are supported by BeoSound 4.

When starting a recording from radio or AUX, there is a delay before the actual recording starts.

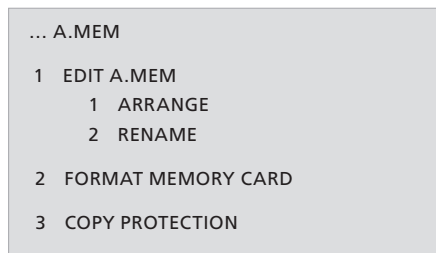

What's on the A.MEM menu ...

EDIT A.MEM ... Select to delete folders or tracks and move or rename folders.

FORMAT MEMORY CARD ... Select to format the memory card – this means that all contents on the card is deleted.

COPY PROTECTION ... Select to permanently override the copy protection of the CDs you wish to record from.

Recordings onto the memory card are encoded in 128 Kbps MP3 quality.

Files copied to the memory card via a PC must be placed in a folder, otherwise they cannot be played back. Folders placed in sublevels are not supported. MP3, WMA are supported formats for playback from the memory card. WMA files protected with DRM (Digital Rights Management) are not supported. MP3/WMA tags are not supported.

To enter the A.MEM menu, press A.MEM, then MENU, enter the SETUP menu and then enter the A.MEM menu.

The submenu EDIT A.MEM is only available at this level, if you have added it as described on page 18.

Useful hints ...

Do not remove the memory card while a recording is in progress or while playing from the memory card, as this may damage the card adversely.

There is one level of folders on the memory card. When recording from an A.AUX source or the radio, two special folders, namely A.AUX and Radio are created. The recordings are placed in these folders respectively. You can then rename these folders if you wish, and new default folders for A.AUX and Radio are created automatically when you make the next recording.

If a CD is copy protected and you try to record it onto the memory card, the music system will prompt you to decide whether or not to override the copy protection. If you choose not to override, the recording is deleted.

To move folders, you turn the wheel to highlight the folder you want to move, press ► to move the folder out of the list and turn the wheel to move it to the new position, press ◀ to move it back into the list.

Tune in and edit radio stations

Let the music system find available radio stations for you. You can store up to 99 radio stations.

Once a station is stored, you access it directly by keying in the program number or by stepping through all the stored stations.

You can rearrange the order in which tuned radio stations appear or delete them via the ARRANGE PROGRAMS menu.

A name, transmitted by the broadcaster, may be shown in the display, but you can name the radio stations yourself.

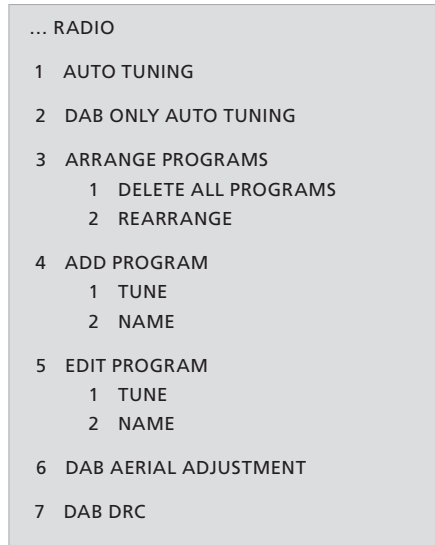

To enter the RADIO menu, press RADIO, then MENU, enter the SETUP menu and then enter the RADIO menu.

If your music system is equipped with the built-in DAB module and DAB stations are broadcast in your area, you can store digital radio stations as well.

What's on the RADIO menu ...

AUTO TUNING ... Use this menu to tune in new radio stations automatically.

DAB ONLY AUTO TUNING ... Use this menu to tune in new DAB stations. For further information, refer to the description on the opposite page.

ARRANGE PROGRAMS ... Use this menu to delete all radio stations, change the order in which your tuned radio stations appear or to delete single, unwanted radio stations from the list of available stations.

ADD PROGRAM ... Use this menu to add new stations, name and store an added station.

EDIT PROGRAM ... Use this menu to fine tune stations, name and store the relevant stations.

The options that are available depend on which band you are currently listening to: FM or DAB. For example, the options for TUNE in the ADD PROGRAM menu for FM are:

BAND ... Shows the current band. Select FM or DAB.

FREQUENCY ... Shows the current frequency. Turn the wheel to start tuning.

FINE TUNE ... Fine-tune a tuned station.

STEREO ... Select YES for stereo sound.

Useful hints ...

When listening to the radio press and hold the wheel to bring up a list of radio programs in the display.

If you have found a radio station but the reception is poor, you can fine tune it via the EDIT PROGRAM menu. You can also enter the exact frequency of a radio station and store it with a program number.

If the stereo signals are not strong enough to produce acceptable sound, the music system automatically switches to mono sound.

Digital Audio Broadcast (DAB) providers send stations in groups called ensembles*.

A channel contains a single ensemble, and an ensemble typically contains 5–10 services*.

When a DAB signal is found, all the stations in the signal are registered. When tuning is complete and more than 99 stations are found, you go through a list of the individual stations and select the ones you wish to store.

When new DAB stations become available, you tune them in with the auto tuning function. This tunes in new stations and leaves previously stored stations unchanged.

*Some DAB providers call an ensemble a 'multiplex', or call a service a 'station'.

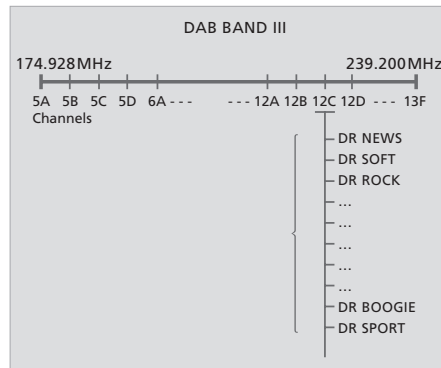

DAB radio stations are broadcast in groups, or ensembles, located on channels.

DAB AERIAL ADJUSTMENT ... This menu contains an indicator bar, which shows the strength of DAB signal reception and the risk of signal drop-out. Watch the indicator bar while you adjust your aerial. When the signal is strong enough, sound is transmitted.

- The indicator bar extends rightward if signal strength increases, and reverses direction if it decreases.
- The indicator bar moves through a shaded and a white field. The shaded field to the left indicates that there is a significant risk of periodic signal drop-out. The white field to the right indicates that the risk of signal drop-out is minimal.

DAB DRC ... For certain DAB stations, you can adjust audio signal compression with the DRC (Dynamic Range Control) function. Compression compensates for sources of noise in your immediate surroundings.

There are twelve possible settings, with three values to guide you:

OFF (no compression)

NOM (recommended by the DAB provider)

MAX (maximum compression, twice that recommended by the DAB provider).

If you have adjusted audio signal compression and you are listening to a DAB station broadcast with DRC, 'DRC' appears in the lower right corner of the display. DAB DRC menu settings have no effect for stations not broadcast with DRC.

If DAB tuning results in too many stations for the Program List ...

- > The available stations appear in the STORE PROGRAM menu.
- > Turn the wheel to move between stations.
- > Press GO to store a station.
- > If the menu is empty, or if you do not want to store more stations, press EXIT to leave the menu.

Radio text – text information about the current station and broadcaster – is supported by BeoSound 4. You can set your system to display radio text via the DISPLAY SETUP menu. For further information, refer to the chapter 'Make option settings' on page 18.

Note that you must select a channel number with a signal before adjusting the aerial. Check your DAB broadcasters' websites for channel numbers.

Audio CD settings

If you name a CD, the name appears in the display whenever you play this CD.

Also additional CD functions are available via the main menu, if you have added them in the MENU OPTIONS menu, refer to page 18 for further information.

The random playback function plays all the tracks on the loaded CD in random order. The repeat playback function plays the loaded CD over and over – for up to 12 hours on end.

The random and repeat functions can be used in conjunction or separately.

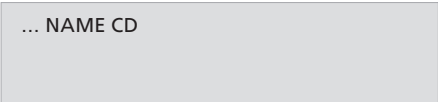

... NAME CD

What's on the NAME CD menu ...

NAME CD ... Use this menu to name the loaded CD. The CD name can then be shown in the display, when the CD is played back.

To enter the CD menu, press CD, then MENU, enter the SETUP menu and then enter the NAME CD menu.

Useful hints ...

You can only name a CD when it is playing. You can store a total of 200 CD names in your music system. Refer to page 10 for further information on naming.

If the CD name list is full, the music system will require you to delete a CD name before entering a new one.

All sound levels are set to neutral values from the factory, but you can make your own sound adjustments and store them.

If speakers are connected directly to your music system, you can adjust the volume, bass and treble levels, or alter the balance between the left and right speaker.

If you store a volume level, your music system starts playing at this level every time you switch it on.

The music system also features a loudness function which you can activate or deactivate. The loudness function makes the music more dynamic. It compensates for the human ear's lack of sensitivity to high and low frequencies when listening to music at low volume.

```
... SOUND
1  VOLUME
2  BALANCE
3  SET TONE (BASS, TREBLE, LOUDNESS)
```

What's on the SOUND menu ...

VOLUME ... Use this menu to preset a volume level for your music system. The maximum volume level that can be stored in this menu is 75.

BALANCE ... Use this menu to adjust the balance between your speakers.

SET TONE (BASS, TREBLE, LOUDNESS) ... Use this menu to adjust bass and treble to your liking and switch the loudness feature on or off.

To enter the SOUND menu, press MENU, enter the SETUP menu and then enter the SOUND menu.

Useful hints ...

If you do not store the sound adjustments you make, the music system will return to the preset sound levels once you switch it off.

Volume level can always be adjusted via the close-up operation panel or the Beo4 remote control.

Make option settings

You can change the basic settings of your music system to your liking. The **OPTIONS** menu allows you to set the clock, switch the Timer function on or off and choose language.

You can also set your preferences for the display and select the sources and functions which should appear when you press the **MENU** button.

When you add **RANDOM** and **REPEAT** to the **MENU OPTIONS**, you can switch the functions on or off for the source you are currently listening to (**CD** or **A.MEM**). This means, if you are listening to a **CD** and switch on the **REPEAT** function, the **CD** will be repeated for up to 12 hours or until you switch it off.

- ```

... OPTIONS
1 SET CLOCK
2 TIMER
3 SELECT LANGUAGE
4 DISPLAY SETUP
 1 RADIO
 2 CD
 3 A.MEM
 4 STATUS (DEFAULT/EXTENDED)
5 MENU OPTIONS

```

### What's on the **OPTIONS** menu ...

**SET CLOCK** ... Use this menu to set the built-in clock to the correct time and date. – This menu is only accessible if your music system is not connected to a television.

**TIMER (ON/OFF)** ... Use this menu to switch the Timer function on or off. Select **ON** to include speakers connected to the music system in a Timer.

**SELECT LANGUAGE** ... Use this menu to select your preferred language for the texts in the display from the list of available languages.

**DISPLAY SETUP** ... Use this menu to select the type and amount of display information for radio, **CD** and **A.MEM**. The settings for **RADIO**, **CD** and **A.MEM** determine what is shown at the top of the display, such as radio text, or a **CD** name. The setting for **STATUS** determines whether display information is shown temporarily – that is, during operation – or permanently.

**MENU OPTIONS** ... Use this menu to add the functions, features and menus to the list which appears when you press **MENU**.

*To enter the **OPTIONS** menu, press **MENU**, enter the **SETUP** menu and then enter the **OPTIONS** menu.*

### Useful hints ...

From the factory, the only menu entry available when you press **MENU** is **SETUP**.

If your music system is connected to other Bang & Olufsen equipment, you may have to set the clock via the connected equipment.

When your music system is connected to a television, Timers are programmed via the television, but if you want them executed on **BeoSound 4**, you must set the **TIMER** menu to **ON**. This requires that you have connected speakers to **BeoSound 4**.

If by accident, you have chosen a language you do not want, you can enter the language menu by pressing **MENU**, move down to the last menu entry, press the wheel, then press 5 and then 3.



You can make the music system start or stop playing at designated times throughout the day and week.

The music system remembers up to 8 such Timers. Set one to wake you up in the morning to the sound from either your favourite CD or radio station and another to switch the music system to standby at a specific time in the evening, or make individual Timers for workdays, weekends and holidays.

You can name your Timers for easy recognition and switch each of your Timers on or off individually.

You can change your Timers at any time.



*The PLAY TIMER menu is only available if you have added it in the OPTIONS menu.*

**What's on the TIMER menu ...**

**ON/OFF ...** Activate or deactivate each of your programmed Timers.

**SOURCE ...** Select a source for your programmed Timer. If you select radio as your Timer source, select a program number too. When you select A.MEM as source, you can select a folder number also.

**START/STOP ...** Enter the start and stop times of your Timer.

**DAYS ...** Select which specific days of the week, this Timer should be activated – you move between the days by means of the arrow buttons. Turn the wheel counter-clockwise to deselect a day, press the wheel to select a day and move on to the next day.

**NAME ...** Name your different Timers for easy recognition.

**Useful hints ...**

To stop the music system, make a Timer with STANDBY as the source.

If you set a Timer for Monday, Tuesday and Thursday, the Timer will be repeated on these days only, every week.

If you have connected the music system to other Bang & Olufsen equipment with Timer function, you must enter your Timer settings on this equipment, as described in its Guide. If you want these settings to apply to BeoSound 4 as well, you must activate the Timer function on BeoSound 4, as described on page 12.

If you want to make use of the Timer function, it is necessary that the built-in clock in the music system is set correctly. For further information, refer to page 18.

## How to use the pincode system

The use of a pincode means that if your music system has been disconnected from the mains for more than approximately 30 minutes, it can only be activated again by switching it on and keying in your pincode via the close-up operation panel.

If the pincode is not entered, the music system automatically switches to standby after approximately three minutes.

You can change your pincode, but it is only possible to change it five times within a period of three hours.

You choose whether or not to activate the pincode system. The pincode system is deactivated when you delete your pincode.

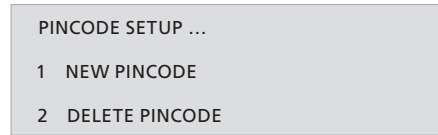

### What's on the PINCODE SETUP menu ...

**NEW PINCODE ...** Use this menu to enter or change your pincode.

**DELETE PINCODE ...** Use this menu to deactivate the pincode system.

### To open for Mastercode input ...

- > While the music system asks for your pincode, press and hold ◀ to open for Mastercode input.
- > Enter the Mastercode.
- > Once you have entered the Mastercode, the pincode system is disabled and the music system is ready for use. To activate the pincode system again, you must enter a new pincode.

*To call up the pincode menu, press MENU and then press ◀ twice followed by STOP.*

### Useful hints ...

If you enter a wrong pincode, you get four more attempts to key in the code, after which the music system switches off and cannot be switched on again for three hours.

If UNLOCK SYSTEM appears in the display the first time you activate a function, and you have not received a PIN code from your Bang & Olufsen retailer, contact your retailer to receive a PIN code before proceeding.

Should you forget your pincode, please contact your Bang & Olufsen retailer who will assist you in getting a Mastercode from Bang & Olufsen. You need the Mastercode to reactivate your music system.

If your music system is used together with other Bang & Olufsen products, refer to the Guides delivered with these products for further explanation on their operation.

Steps through your radio stations, or tracks. When RANDOM or REPEAT is shown in the Beo4 display, press ▲ to activate the function, and press ▼ to deactivate it

Searches through a CD, steps between folders, or moves left or right in menus

Resumes playback, activates the source and accepts settings, or activates a function shown in the Beo4 display, such as CLOCK

Displays extra 'buttons', such as RANDOM, REPEAT, N.RADIO or N.MUSIC\*

Pauses CD and A.MEM playback at any time



GO

LIST

RANDOM  
N.MUSIC

STOP

**RADIO**

Switches on radio

**CD**

Switches on CD

**A.MEM**

Starts playback from a loaded memory card

**0 – 9**

Enters radio station numbers, track numbers. Use the number buttons to select a numbered menu item

**MENU**

Enters the menu system

**EXIT**

Leaves the menu system



Turns the volume up or down. Press in the middle to mute speakers, press again to restore sound



Switches your music system to standby

\*In order to display the relevant extra 'buttons' on the Beo4, you must add them to the Beo4 list: Add RANDOM and REPEAT to Beo4 to use these functions. Add A.AUX to be able to switch on any other source connected to the AUX-socket. Refer to Beo4's own Guide for further information.

## Setting-up

We recommend that you follow this procedure when you set up your music system:

- 1 Place the music system where you want to use it.
- 2 Set up your speakers and any auxiliary equipment.
- 3 Connect all cables to their sockets on the socket panel of the music system – remember not to connect it to the mains yet!
- 4 Arrange the cables in the cable cover grooves and attach the cable guide.
- 5 Mount the glass door.
- 6 Connect the products to the mains.

### Cautions

Make sure that the music system is set up, placed and connected, in accordance with the instructions in this guide. To prevent injury, use Bang & Olufsen approved stands and brackets only.

Place your music system on a firm surface, preferably on the table, sideboard or stand where you want it placed permanently.

The music system is designed for indoor use in dry, domestic environments only, and for use within a temperature range of 10–40° C (50–105° F).

Avoid placing the system in direct sunlight, near radiators or other sources of heat.

Allow a space of at least 5 cm (2") each side of the music system for adequate ventilation. Remember to leave enough space at the top for the glass door to open.

If you want to hang the music system on a wall, make sure that you use the correct size and type of screws and wall plugs for mounting the wall bracket (optional accessory) and the BeoSound. The type of screws and wall plugs will depend on the material and construction of the wall.

Do not switch on the mains for any products in your system, until after you have connected all the cables.

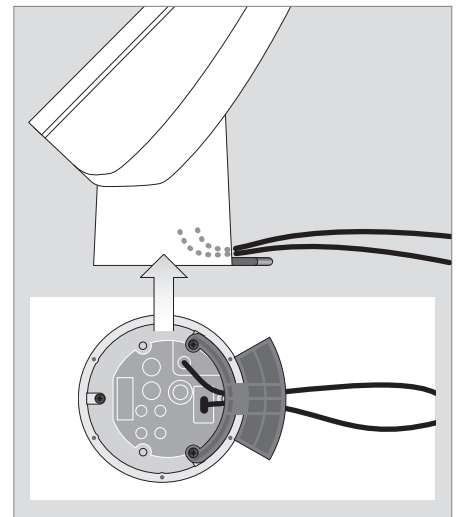
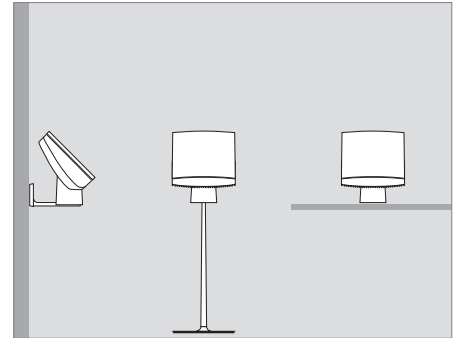

**Cable guide and cables:** *If you place the music system on its own, make sure the cables are lead through the cable guide. Otherwise, the mains lead can be tugged free from the socket.*

*If you want to mount the music system on a stand or bracket, you must remove the cable guide. For further information on how to mount your music system on a stand or bracket, refer to the Guide enclosed with the stand or bracket.*

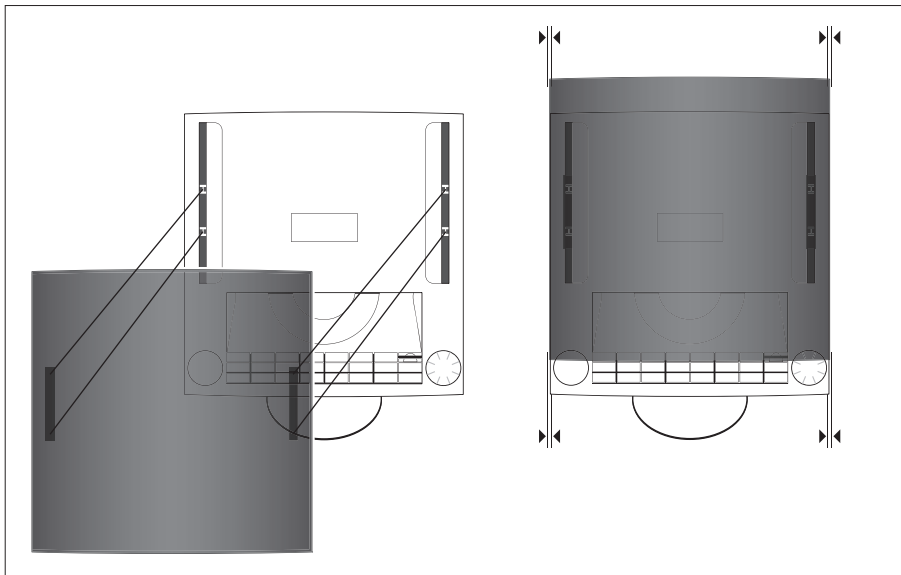

**Glass door:** We recommend that the music system is disconnected from the mains supply, when you mount the glass door.

- > Position the glass door so that the fastening points on the glass door are aligned with the corresponding fastening socket on the music system.
- > Make sure that the left and right edges of the glass door are aligned with the left and right edges of the music system.
- > Press gently on the glass door (on the fastening points) until you hear a click. The click indicates that the glass door is seated properly.

*The glass door can be removed, for example if you want to clean it on the inside. To remove the glass door, open it and disconnect the music system from the mains supply. Press gently on the top part of the glass door, and it will come loose.*

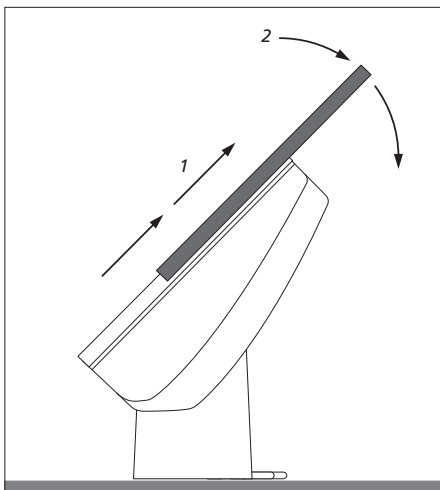

## Connect the cables

The socket panel is placed at the base of your music system. Use the diagram and graphics imprinted on the socket panel unit when locating the sockets.

Do not connect your system to the mains until you have finished connecting all other cables.

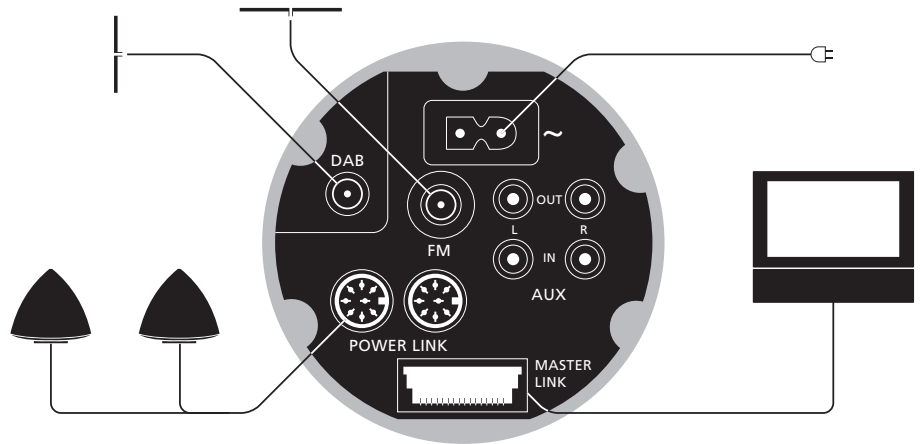

### Aerial connections – FM/DAB\*

We recommend that you connect your DAB aerial before connecting your other aerials.

- Connect your DAB aerial to the socket marked DAB, and your FM aerial to the socket marked FM.

### When using an FM dipole aerial ...

- Tune in to the radio station you want, then turn the aerial horizontally until you receive the best possible signal.

### When using a DAB aerial ...

- Use the DAB AERIAL ADJUSTMENT menu, described on page 15, to find out where to place your aerial. The menu lets you know how strong the DAB signal is.
- Make sure that you hang or mount the aerial vertically.

*Do not mount your music system permanently – for example, on a wall bracket – until you have found out where the signal is strongest and placed your system accordingly!*

\*NOTE! The DAB socket is only available if your music system is equipped with the built-in DAB module.

**Mains connection – ~**

Plug the mains cord into the socket marked ~ on the socket panel, but do not connect it to the mains before you have finished all connections. The music system can only be switched off completely by disconnecting it from the wall socket. The mains plug of the power supply cord must remain readily operable.

**Loudspeaker connections – Power Link**

Connect your active speakers to the sockets marked Power Link. Refer to the Guides for the BeoLab Loudspeakers.

*Remember to set L • R • LINE switch on the BeoLab speakers to L and R (left and right), respectively.*

*When headphones are plugged in, the speakers, connected to your music system, are muted.*

*Prolonged listening at a high volume level may cause hearing damages!*

**Master Link connections**

Use a Master Link cable to connect the sockets marked Master Link on the socket panel and the television.

The socket is also used for BeoLink distribution of sound throughout the house.

**Connect auxiliary equipment ...****AUX IN L – R**

For connection of auxiliary equipment, such as a record player.

**AUX OUT L – R**

For connection of auxiliary equipment, such as a mini disc.

## Audio/video setup

You can use your music system as a stand-alone system or as a Audio/Video system, if you connect the systems with a Master Link cable.

If you connect your music system and your video system, you must make sure that they are set up to function together. This means that you have set it to the correct Option with Beo4 as described on this page.

### To program Option for your audio system with the Beo4 remote control ...

- > While holding down the **•** button, press **LIST**.
- > Let go of both buttons.
- > Press **LIST** repeatedly until **OPTION?** is shown in the Beo4 display and press **GO**.
- > Press **LIST** repeatedly until **A.OPT** is shown in the Beo4 display and then key in the appropriate number (**0**, **1**, **2**, **5** or **6**).

Choose **V.OPT** to program Option for your video system.

### The music system has five different Option settings:

**Option 0.** Used when your music system is connected to your video system and no speakers are connected directly to your music system.

*If you wish to change the Option setting to 0 from any other setting, change it first to 1 before changing it to 0.*

**Option 1.** Used when your music system is set up on its own or connected to a video system, when speakers are connected to your music system.

**Option 2.** Used when your music system is set up in one room and connected to a video system set up in another room.

**Option 5.** Used when your music system is set up in a link room which also comprises a Bang & Olufsen television.

**Option 6.** Used when your music system is set up in a link room *without* a Bang & Olufsen television.

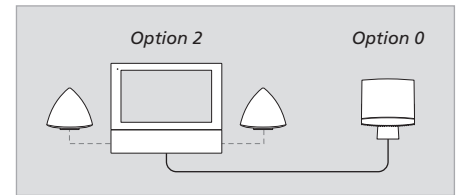

An Audio/Video system. When your music system is connected to a video system and the speakers are connected to the video system, the video system takes over some of the functions mentioned in this Guide, for example programming a Timer.

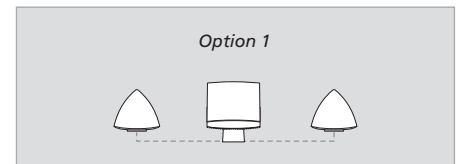

The music system as a stand-alone system.

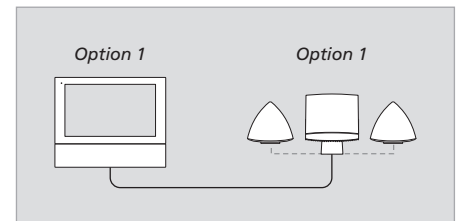

An Audio/Video integrated system set up in one room.

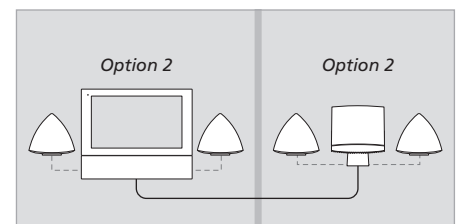

An Audio/Video integrated system set up in two rooms.



Normal maintenance, such as cleaning the music system, is the responsibility of the user. To achieve the best result, please follow the instructions.

Please make sure to treat the glass door with great care. If it cracks or chips, or if it is damaged in any other way, it should be replaced immediately as it could otherwise cause bodily harm. You can order replacement doors through a Bang & Olufsen retailer.

## Cleaning

Before you clean the music system, we recommend that you disconnect it from the mains to prevent the glass door from opening and closing. While the music system is disconnected, you can open or close the glass door manually. It requires only a little, gentle force to do so.

Use a soft, dry cloth to wipe dust off the music system.

The glass door can be removed and cleaned on the inside, if required – see page 23 in this Guide. To clean the glass door, we recommend that you use a mild window cleaner.

*Do not use alcohol or other solvents to clean any part of the music system, stand or bracket. We do not recommend using special cleaning CDs in the music system.*

## Memory card

To ensure a long lifetime, memory cards must be handled with care. Always keep the card inside the music system, or in the cartridge supplied with the card. Please note that recording or formatting will not be possible if you have write-protected the card.

If playback problems arise, we recommend that you format the memory card. Remember that formatting erases all contents on the memory card.



**Handling your CDs:** *Should the CD become soiled by fingerprints, dust or dirt, it can be wiped clean with a lint-free, soft, dry cloth. No solvents or abrasive cleaners should ever be used on the CD and always wipe the CD in a straight line from centre to edge. Avoid extreme heat and humidity, and never write on your CDs.*

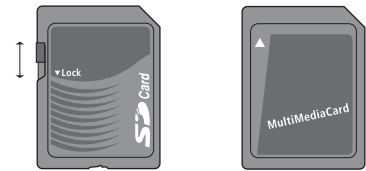

*You can write-protect the SD-card by moving the slider down.*

# Index

## A.MEM

Delete from memory card, *13*  
 Insert a memory card, *6*  
 Name folders and tracks, *10*  
 Play from A.MEM, *7*  
 Random playback, *18*  
 Record onto memory card, *13*  
 Repeated playback, *18*

## Audio/Video system

Connect your music system to a video system,  
*25*  
 Option programming, *26*

## Beo4 remote control

Use the Beo4 remote control, *21*

## Cables

Arrange the cables, *23*  
 Connect the cables, *24*

## CD player

Load a CD, *4*  
 Name CDs, *10*  
 Play a CD, *7*  
 Play tracks in random order, *18*  
 Repeat a CD for up to 12 hours, *18*

## Cleaning

Handling your CDs, *27*  
 Looking after your music system, *27*

## Clock

Enter settings for the built-in clock, *18*

## Connections

Aerial connections, *24*  
 Connect headphones, *4*  
 Connect speakers, *25*  
 Connect your music system to a video system,  
*25*

## Contact

Contact Bang & Olufsen, *30*

## DAB radio stations

Adjust DAB audio signal compression – DAB  
 DRC, *15*  
 Adjust your DAB aerial, *15*  
 DAB aerial socket, *24*  
 Tune in DAB radio stations, *15*

## Delete

Delete CD names, *16*  
 Delete radio stations, *14*  
 Format memory card, *13*

## Displays

Understand and change the displayed  
 information, *4 and 18*

## First-time setup

The first-time setup procedure, *11*

## Headphones

Connect headphones, *4*

## Indicator light

The indicator light, *4*

## Language

Change the language in the display, *18*

## Loudspeakers

Connect loudspeakers, *25*

## Maintenance

Looking after your music system, *27*

## Master Link

Audio/Video setup, 26  
Option programming, 26

## Memory card

Insert memory card, 6  
Compatible memory cards, 13  
Format memory card, 13  
Record onto memory card, 13  
Write-protect memory card, 27

## Menus

How to read menu symbols, 8  
How to use the menus, 9

## Naming

Name a CD, 10  
Name a folder, 10  
Name a radio station, 10

## N.Music

Play N.MUSIC, 12

## N.Radio

Play N.RADIO, 12

## Operation panel

Overview of the operation panel, 6

## Option

Program your music system to the correct  
Option, 26

## Pincode

Activate the pincode system, 20  
Change or delete your pincode, 20  
Did you forget your pincode?, 20  
Open for Mastercode, 20  
Use your pincode, 20

## Placement

Cautions, 22

## Radio

Delete radio stations, 14  
Move radio stations, 14  
Name radio stations, 10  
Switch on the radio, 7  
Tune in radio stations, 14

## Random

Play tracks in random order, 18

## Repeat

Repeat a CD, 18

## Settings

Set the clock, 18  
Sound adjustments, 17

## Socket panel

Overview of sockets, 24

## Sound

Adjust the sound volume, 6  
Change sound from stereo to mono, 14  
Change volume, bass, treble or loudness, 17

## Timer

Enter settings for the built-in clock, 18  
Make your music system start or stop  
automatically, 19  
Switch on the Timer play function, 19  
To view, edit or delete a Timer, 19

**For your information ...**

Your needs as a user are given careful consideration during the design and development process of a Bang & Olufsen product and we strive to make our products easy and comfortable to operate.

Therefore, we hope that you will take the time to tell us about your experiences with your Bang & Olufsen product. Anything which you consider important – positive or negative – may help us in our efforts to refine our products.

Thank you!

*Write to:* Bang & Olufsen a/s  
Customer Service  
Peter Bangs Vej 15  
DK-7600 Struer

*or call/fax:* Bang & Olufsen  
Customer Service  
+45 96 84 45 25 (phone)  
+45 97 85 39 11 (fax)

*or email via:* [www.bang-olufsen.com](http://www.bang-olufsen.com)



### **Waste Electrical and Electronic Equipment (WEEE) – Environmental protection**

The European Parliament and the Council of the European Union have issued the Waste Electrical and Electronic Equipment Directive. The purpose of the Directive is the prevention of waste of electrical and electronic equipment, and to promote the reuse and recycling and other forms of recovery of such waste. As such the Directive concerns producers, distributors and consumers.

The WEEE directive requires that both manufacturers and end-consumers dispose of electrical and electronic equipment and parts in an environmentally safe manner, and that equipment and waste are reused or recovered for their materials or energy. Electrical and electronic equipment and parts must not be disposed of with ordinary household refuse; all electrical and electronic equipment and parts must be collected and disposed of separately.

Products and equipment which must be collected for reuse, recycling and other forms of recovery are marked with the pictogram shown.

When disposing of electrical and electronic equipment by use of the collection systems available in your country, you protect the environment, human health and contribute to the prudent and rational use of natural resources. Collecting electrical and electronic equipment and waste prevents the potential contamination of nature with the hazardous substances which may be present in electrical and electronic products and equipment.

Your Bang & Olufsen retailer will assist with and advise you of the correct way of disposal in your country.



This product fulfils the conditions stated in the EEU directives 89/336 and 73/23.



The black and yellow label on the compact disc player serves as a warning that the apparatus contains a laser system and is classified as a class 1 laser product. In case any difficulties arise with the compact disc player, please contact a Bang & Olufsen retailer. The apparatus must be opened by qualified service personnel only.



**CAUTION:** The use of any controls, adjustments or procedures other than those specified herein may result in hazardous radiation exposure.

This product incorporates copyright protection technology that is protected by U.S. patents 4,631,603; 4,577,216; 4,819,098; 4,907,093; and 6,516,132 and other intellectual property rights. Use of this copyright protection technology must be authorized by Macrovision, and is intended for home and other limited viewing uses only unless otherwise authorized by Macrovision. Reverse engineering or disassembly is prohibited.

***For the US-market only!***

**NOTE:** This equipment has been tested and found to comply with the limits for a class B digital device, pursuant to part 15 of the FCC Rules. These limits are designed to provide reasonable protection against harmful interference in a residential installation.

This equipment generates, uses and can radiate radio frequency energy and, if not installed and used in accordance with the instructions, may cause harmful interference to radio communications. However, there is no guarantee that interference will not occur in a particular installation. If this equipment does cause harmful interference to radio or television reception, which can be determined by turning the equipment off and on, the user is encouraged to try to correct the interference by one or more of the following measures:

- Reorient or relocate the receiving antenna.
- Increase the separation between the equipment and receiver.
- Connect the equipment into an outlet on a circuit different from that to which the receiver is connected.
- Consult the dealer or an experienced radio/TV technician for help.

***For the Canadian market only!***

This class B digital apparatus meets all requirements of the Canadian Interference-Causing Equipment Regulations.

Technical specifications, features and the use thereof are subject to change without notice.



