

BeoTalk 1200

BANG & OLUFSEN **BO**

Introduction to BeoTalk 1200

BeoTalk 1200 cherishes the sanctity of private life and gives you independence...

...It is up to you to decide with whom you want to talk and when! Look at the display or hear who is calling.

...Hear or see who called and when! The News list will show you all the incoming calls. Even those who didn't leave a message!

...Play the received messages and Internal messages exactly when it suits you and as many times you want to.

...Record up to 3 different outgoing announcements, one of which offers the possibility of giving a specific announcement to selected telephone numbers.

...It is up to you to decide from whom you want to receive messages! Connect Rejection of incoming calls to avoid specific unwanted callers.

The local control of BeoTalk 1200 has two operating levels...

The primary operation takes place by means of the three keys on the front of the telephone answering machine.

The secondary operation takes place by means of the keys under the cover. These keys conceal the numerous functions which make it possible to choose individual combinations.

The remote control enables you to operate your BeoTalk 1200 even when you are not at home.

Write to:
Bang & Olufsen a/s
Customer Service
Peter Bangs Vej 15
DK-7600 Struer

or fax:
Bang & Olufsen
Customer Service
+45 97 85 39 11

or e-mail:
beoinfo1@bang-olufsen.dk

Visit our Web-site on:
www.bang-olufsen.com

Caller ID subscription

BeoTalk 1200 has a built-in Caller ID function so that you can see who is calling when your telephone starts ringing.

The Voice Announcement function allows you also to hear who is calling! To make the most of all the features of your BeoTalk 1200 it is necessary that you subscribe to the Caller ID service offered by your telephone company.

A Caller ID subscription is a condition for using the Voice Announcement Phonebook, Caller ID, Group Announcement and Rejection of incoming calls.

Without a Caller ID subscription you can use your BeoTalk 1200 as a traditional telephone answering machine with (→) Announcement Only and (↔) Announcement and Message.

8 Guide to BeoTalk 1200

- Primary operation panel, 8
- Secondary operation panel, 9
- Description of BeoTalk 1200 keyboard, 10
- Description of the symbols in the display, 12

14 Installation of BeoTalk 1200

- Installation, 14
- Wall mounting, 14
- Connection, 14
- Adjusting the display contrast, 15
- Setting the clock, 15
- Selecting 24-hour or 12-hour clock, 16

17 Operation of BeoTalk 1200

- Primary operation, 17
- User's guide setup, 17
- Operating principles, 17
- Recording and playing outgoing announcements, 18
- Activating and deactivating the answering machine function, 19
- Playing News (a message, Voice Announcement or a Caller ID number), 20
- Activating and deactivating the News indicator, 21
- Storing News in the News list, 21
- Deleting News, 21
- Internal message, 22
- Listening-in, 22
- Entering numbers and recording names into the Voice Announcement Phonebook, 23
- Activating and deactivating the Voice Announcement Phonebook, 24
- Playing and editing the Phonebook, 24

- Transferring phone numbers from the News list to the Phonebook, 25
- Recording announcements for no Caller ID, and for phone numbers which are not in the Phonebook, 25
- Rejection of incoming calls, 26
- Transferring phone numbers from the News list or the Phonebook to the Rejection list, 26
- Activating and deactivating the Rejection function, 27
- Entering phone numbers in the Group Announcement list, 28
- Activating and deactivating Group Announcement, 28
- Transferring phone numbers from the News list or the Phonebook to the Group Announcement list, 29
- Editing Group Announcement list or Rejection list, 29
- Volume, 30
- Ringling time, 30

31 Remote control of BeoTalk 1200

- PIN-code for remote control, 31
- Playing News from an external telephone, 32
- Activating the answering machine from an external telephone, 33
- Recording a new announcement from an external telephone, 33
- Remote control of Internal messages, 34
- Toll saver, 35

36 Worth knowing – about troubleshooting

38 Technical information on BeoTalk 1200

- Capacity, 38
- Memory, 38
- Automatic deletion of News, 38
- Sound signals, 39

40 Technical data

- Approvals, 40
- Cleaning, 40
- Data, 40

Primary operation panel

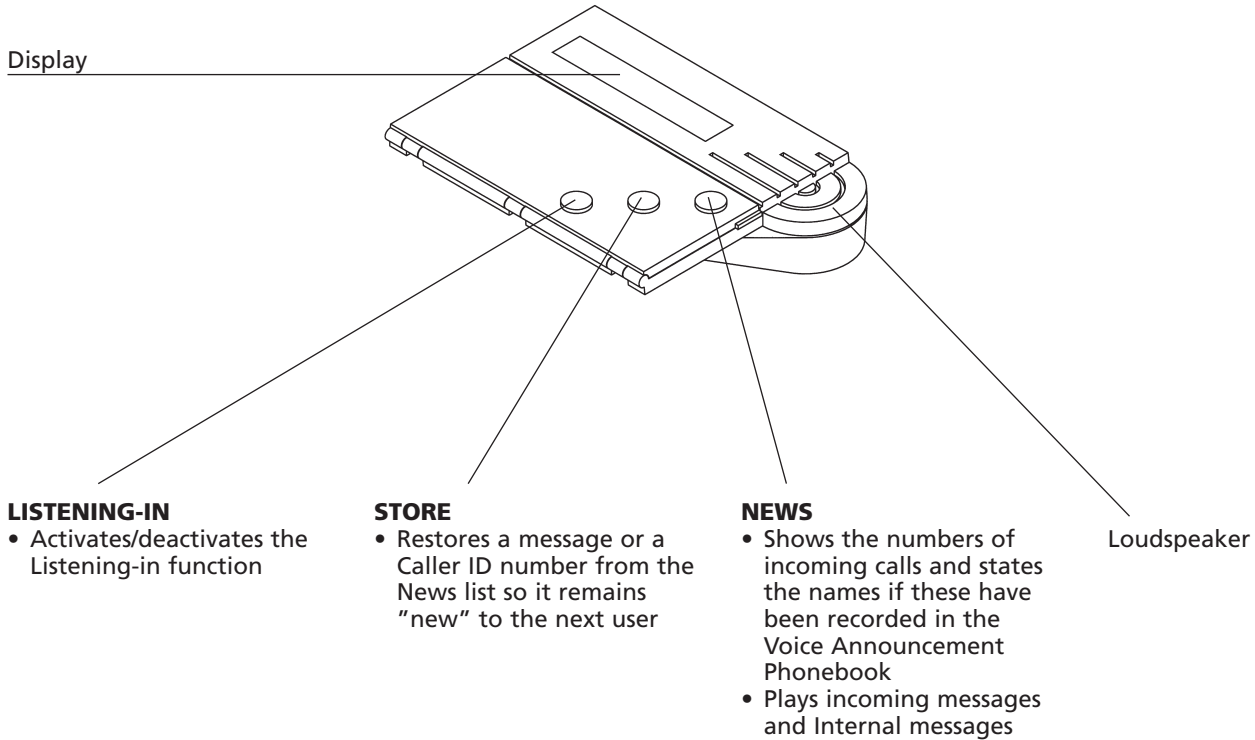

Secondary operation panel

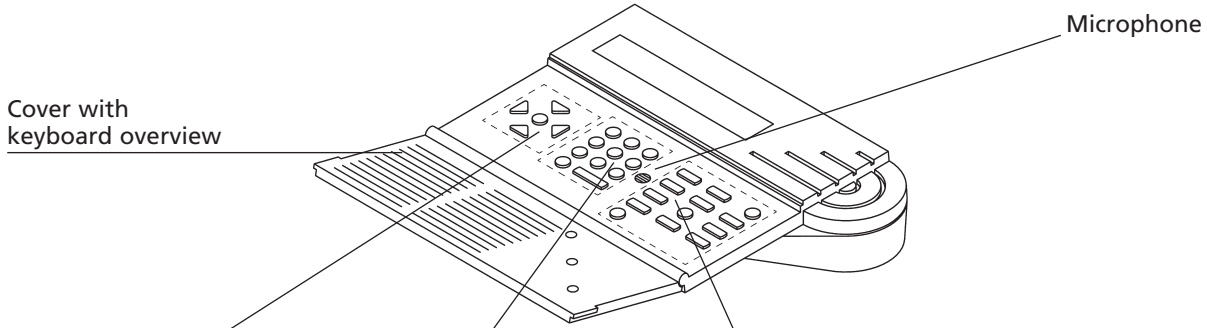

Cover with keyboard overview

Microphone

Type of announcement

- Choosing Announcement Only, Announcement and Message, and Group Announcement
- Recording announcements and Internal messages
- Recording names into the Voice Announcement Phonebook

Entering

- Entering of numbers
- Storing numbers

Functions

- Functions and settings



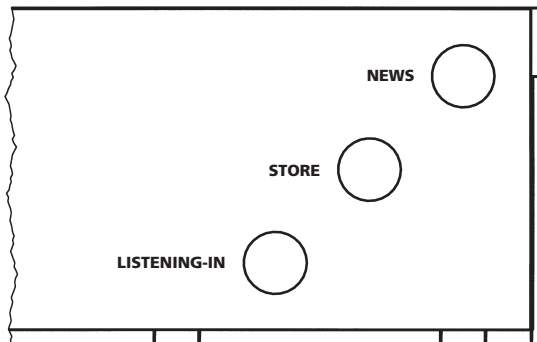

Description of BeoTalk 1200 keyboard

Primary operation panel

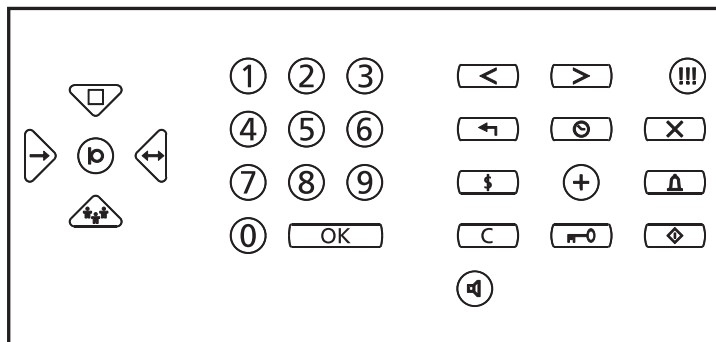

Secondary operation panel



NEWS or !!!	<i>News</i>	<ul style="list-style-type: none"> • Shows callers' numbers in the News list (Caller ID function), 20 • Plays incoming and Internal messages, 20 • States the callers' names if these have been stored in the Phonebook, 23
STORE or +	<i>Store</i>	<ul style="list-style-type: none"> • Restores a message or a Caller ID number in the News list, 21
LISTENING-IN or 	<i>Listening-in</i>	<ul style="list-style-type: none"> • Activates/deactivates Listening-in, 22
→	<i>Announcement Only</i>	<ul style="list-style-type: none"> • Records and plays outgoing announcements, 18 • Activates/deactivates Announcement Only, 19
↔	<i>Announcement and Message</i>	<ul style="list-style-type: none"> • Records and plays outgoing announcements, 18 • Activates/deactivates Announcement and Message, 19
	<i>Group Announcement</i>	<ul style="list-style-type: none"> • Records and plays outgoing announcements, 18 • Entering phone numbers in the Group Announcement list, 28 • Activates/deactivates Group Announcement, 28
	<i>Recording</i>	<ul style="list-style-type: none"> • Records outgoing announcements, Internal messages and records names into the Phonebook, 18, 22, 23
	<i>Voice Announcement Phonebook</i>	<ul style="list-style-type: none"> • Records names into the Phonebook, 23 • Activates/deactivates the Voice Announcement Phonebook, 24 • Playing and editing the Phonebook, 24
0 ... 9	<i>Number keys</i>	<ul style="list-style-type: none"> • Setting of clock, 15 • Entering phone numbers into Phonebook, 23 • Entering phone numbers in Rejection list, 26 • Entering phone numbers in the Group Announcement list, 28 • Entering ringing time, 30 • Entering PIN-code for remote control, 31

OK	<i>Store/status</i>	<ul style="list-style-type: none"> • Stores entered digits, 17 • Shows memory occupied, 38
<	<i>Volume/cursor</i>	<ul style="list-style-type: none"> • Decreases the volume, 30 • Moves to previous digit, 17 • Moves to previous phone number, 17
>	<i>Volume/cursor</i>	<ul style="list-style-type: none"> • Increases the volume, 30 • Moves to next digit, 17 • Moves to next phone number, 17
↶	<i>Cancel operation</i>	<ul style="list-style-type: none"> • Cancels an operation, 17
🕒	<i>Clock</i>	<ul style="list-style-type: none"> • Setting of clock, 15
✕	<i>Rejection of incoming calls</i>	<ul style="list-style-type: none"> • Entering phone numbers in the Rejection list, 26 • Activates/deactivates the Rejection function, 27
\$	<i>Toll saver</i>	<ul style="list-style-type: none"> • Activates/deactivates the Toll saver, 35
🔔	<i>Ringing time</i>	<ul style="list-style-type: none"> • Setting of ringing time, 30
C	<i>Delete an entry</i>	<ul style="list-style-type: none"> • Deletes a digit during entering of numbers, 17 • Deletes News, 21 • Deletes a phone number in the Phonebook, 24 • Deletes a phone number in the Group Announcement and Rejection list, 29
🔑	<i>PIN-code</i>	<ul style="list-style-type: none"> • Entering PIN-code for remote control, 31
◇	<i>On/off</i>	<ul style="list-style-type: none"> • Activates/deactivates the answering machine function, 19

Description of the symbols in the display

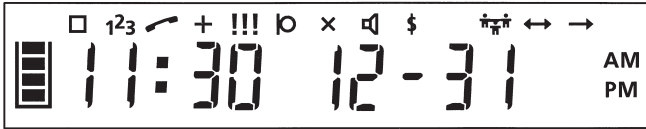

The display is brightly illuminated when the telephone line is engaged, during operation and when there are new messages and new phone numbers in the News list. Otherwise, the display is dimmed.

Symbols that are always illuminated when the function is activated...

	Shows how much of the memory has been used
0...9	Shows time and date
0...9	Shows phone numbers
:	Separates hours and minutes
-	Separates day and month
AM PM	24-hour or 12-hour time display selected
	A telephone on the same line is being used
123	New numbers and/or Voice Announcements in the News list
123 !!!	New numbers and messages in the News list
+ !!!	Is shown when messages have been stored
	Recording of outgoing announcements, Internal messages and names into the Phonebook
	Rejection of incoming calls activated
	Voice Announcement Phonebook activated
	Listening-in activated
\$	Toll saver activated

	Group Announcement has been recorded and the function activated
	Announcement and Message has been recorded and the function activated
	Announcement Only has been recorded and the function activated
-	No numbers in the phone number lists or in the Rejection list
L	Is shown when an Internal message is being played

Symbols that flash...

	Group Announcement has been deactivated
	No announcement has been recorded for the type of announcement chosen
	Rejection function deactivated
	Voice Announcement Phonebook deactivated
	Memory is full

Symbols that flash shortly 4 times and then disappear...

	Listening-in deactivated
	Toll saver deactivated
	It is not possible to activate the function because no announcement has been recorded or there are no phone numbers in the list

Installation

BeoTalk 1200 can be either placed on the table or mounted on the wall using the enclosed bracket and screws.

BeoTalk 1200 should not be placed in dusty or dirty environments, nor be exposed to direct moisture.

Wall mounting

- Mount the wall bracket using the enclosed screws.
- Lead the cord down through the slot on the back of BeoTalk 1200.
- Lead the cord behind the pin on the wall bracket so that the cord is held against the wall.
- Place BeoTalk 1200 on the wall bracket.

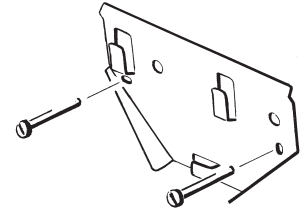

Connection

- Connect the cords as shown on the drawing.
- Insert the wall plug into your telephone wall jack.
- Insert the A/C adapter into the A/C wall plug.

By using the enclosed adapter you are able to connect both your telephone and the BeoTalk 1200 to the same telephone wall jack.

If you want to extend the cords, please be aware that only the cord from LINE to the telephone network can be extended. Exchanging the other cords will affect the functions of BeoTalk 1200.

In order for Caller ID to function, the BeoTalk 1200 must be connected before the switchboard, if any.

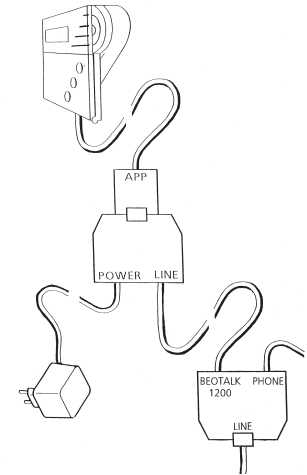

Settings

Before you start using your BeoTalk 1200, we recommend you to adjust the display contrast so that it fits the setup. At the same time it is a good idea to set the clock.

Adjusting the display contrast

The display contrast can be set to two different levels. Choose the most convenient level. This depends on whether BeoTalk 1200 is mounted on the wall or placed on a table.

Setting the clock

HOURS:MINUTES MONTH - DAY



Adjusting the display contrast

Press **+ 0 +**

The display contrast switches to the other level

Set time and date

Press **☉**

Set time and date using the keys 0-9

The cursor flashes below the first digit

Press **OK** to store the setting

Present time is shown in the display

While setting the time...

Press **>** to move the cursor to the right

The cursor is moved to the right

Press **<** to move the cursor to the left

The cursor is moved to the left

Press **←** to cancel the setting



The setting is canceled

Selecting 24-hour or 12-hour clock

Set the clock in the display of BeoTalk 1200 to your choice:

1. Shows the time as a 12-hour clock with AM/PM.
2. Shows the time as a 24-hour clock.



Selecting 24-hour or 12-hour clock

Press  until the desired setting is displayed *Each time  is pressed, the display will change between 12-hour clock and 24-hour clock*

Selecting AM or PM for 12-hour clock

Press  until AM or PM is shown in the display *The cursor flashes below the first digit*

Press  to move the cursor to AM/PM *The cursor flashes below AM/PM*

Press  until the desired setting is displayed *Each time  is pressed, the time will change between AM and PM*

Press **OK** to store the setting *The setting is stored*

Operation of BeoTalk 1200

Primary operation

The three keys on the primary operation panel are supplemented by keys on the secondary operation panel:

NEWS and !!!

Plays messages, which can be:

- Calls where the Caller ID is shown
- Calls where the name is stated if this has been recorded into the Voice Announcement Phonebook
- Messages recorded on the answering machine.

STORE and +

Restores a message or a phone number from the News list so it remains "new" to the next user.

LISTENING-IN and 🔊

Activates/deactivates the Listening-in function.

We recommend that your telephone answering machine is activated all the time. In that way your day-to-day operation will be more convenient.

User's guide setup

This column shows the operation, either step by step or in the form of an explanation:

This column explains the display or the consequence of an operation:

General operating principles...

Press	>	to move the cursor to the right	<i>The cursor in the display moves to the next digit or the next phone number</i>
Press	<	to move the cursor to the left	<i>The cursor in the display moves to the previous digit or the previous phone number</i>
Press	↵	to cancel an operation	<i>The whole new entry is canceled</i>
Press	C	to delete a digit ¹⁾	<i>The digit chosen is deleted</i>
Press	OK	to conclude an entering of digits	<i>The entry is stored</i>
Press	+ or STORE	to restore	<i>The incoming message, Internal message or Caller ID number is restored as "News"</i>

¹⁾ not when setting the clock

Recording an announcement

With BeoTalk 1200 you have the possibility of recording 3 different types of outgoing announcements:

- *Announcement Only...* One-way announcement, not allowing the caller to leave a message (only an announcement function). Could for example be information on opening hours.
- *Announcement and Message...* The traditional answering machine function – the caller can leave a message after having listened to your announcement.
- *Group Announcement...* A special outgoing announcement to up to 30 previously stored phone numbers, allowing the caller to leave a message. Record for example your holiday plans for family and friends! See pages 28-29 for information on how to enter phone numbers in the Group Announcement list.

When you record a new announcement, the old one of that type will be deleted automatically.

Record a test announcement to find the best voice intensity and distance to the microphone.

Recording an outgoing announcement

Press → or ↔ or *#* → or ↔ or *#* is shown in the display

Press Ⓟ Ⓟ is shown in the display. The time is counting from 0 : 00

Record an announcement

Press Ⓟ The announcement is played back and the duration is shown

Replaying an outgoing announcement

Press →
Press !!! Announcement Only is played

or
Press ↔
Press !!! Announcement and Message is played

or
Press *#*
Press !!! Group Announcement is played

If no announcement has been recorded, Ⓟ will be flashing

Activating the answering machine function



After recording an announcement, select the type of announcement desired and activate the answering machine function.

Announcement Only, Announcement and Message, and Group Announcement can only be activated if you have recorded an announcement.

Note!



To activate Group Announcement you also need to enter minimum one phone number into the Group Announcement list. See page 28.

Activating the answering machine function

Press → or ↔ or  *→ or ↔ or  is shown constantly in the display*

Press  *The answering machine function has been activated*

Deactivating the answering machine function

Press  until → or ↔ or  disappears from the display *The answering machine function has been deactivated*

The News function

News may be messages, calls with Caller ID in the form of Voice Announcement or just the phone number, or Internal messages. News are shown in the illuminated display:

123 A new number and/or Voice Announcements

123 !!! A new number with a message.

At the same time a flashing digit (max. 9) will tell you how many News you have received.

If the phone number has more than 10 digits, the index number will not be shown. BeoTalk 1200 can handle up to 13 digits.

Even though BeoTalk 1200 has received a call and is actually playing an announcement, at any time you can cut in and continue the conversation by lifting off the handset of your telephone.

The phone numbers and the messages, if any, of the 50 latest calls received are stored in the News list.

All numbers from which you have received a call are transferred to the News list - even when the answering machine function has been deactivated.

Playing News

Press **NEWS** or **!!!**

While playing...

Advance in the list...

Press **NEWS** or **!!!** or **>** to listen to the next call

Go back in the list

Hold **NEWS** or **!!!** down until the previous number is shown

or
press **<**

The playing of News will start – the latest number is shown in the display alternating with the time of the call, e.g.:

847 299 9380 11:35 05-21

If the caller's name has been recorded into the Phonebook and no message has been left, the name of the caller will be played

*The next number is shown in the display alternating with the time of the call. **123** and **!!!** is turned off in the display when the latest call has been shown and the name, if any, stated or when the message attached to it has been played*

If you have received a call from a phone number which is not in the Phonebook, the number will be shown and the answering machine will give off three brief tones unless you have recorded a code -0 "name", see page 25

You can choose to deactivate the function showing unread News if you e.g. have a telephone with another News indicator. If the News indicator is deactivated, the symbols **123** and **!!!** will still be shown in the display to indicate News, but the display will not be illuminated and there will be no flashing digit showing the number of News.

Storing News

In some cases you may wish to save News which you have played in order that the next user of the BeoTalk 1200 will find the News as "new". News will only remain "new" until played again, but can be stored again as often as you wish by using the **STORE** or **+** button.

Deleting News

It is not necessary to delete messages and phone numbers from the News list after playing them. BeoTalk 1200 automatically deletes the oldest News to make room for new ones.

When you play an Internal message, an L will be shown in the display. See next page for further information on Internal messages.

Activating/deactivating News indicator

Press **+ 9 +**

The News indicator is deactivated

Press **+ 8 +**

The News indicator is activated

Storing News

Press **STORE** or **+** while playing the News to store it as "new"

+ !!! is shown in the display

Deleting News

Press **C** to delete the message being played

- - - is shown in the display

Playing News you have already heard

After playing new messages...

Press **NEWS** or **!!!** for each message you want to play



The number is shown alternating with the time of the call

Internal message

With the function Internal message you can record a message to another user of the answering machine. The message is played in the same way as a normal message.

It is also possible to play and change an Internal message from another telephone, see page 34 for remote control of Internal messages.

Recording an Internal message

Press 
Record a message
Press 

 is shown in the display

The message is played back and the duration is shown in the display

Listening-in

When you activate Listening-in, you can listen to the "conversation" between the answering machine and the person calling.

If you activate or deactivate Listening-in while BeoTalk 1200 is answering a call, this function will only be operational during the call in progress.

Activating Listening-in

Press **LISTENING-IN** or 

 is shown in the display

Deactivating Listening-in

Press **LISTENING-IN** or 

 flashes 4 times after which it is turned off

The Phonebook in BeoTalk 1200

BeoTalk 1200 allows the user to record announcements with the phone numbers in the built-in Phonebook.

The recording of an announcement with a phone number means that the name will be played when a call is received from this phone number. At the same time, the number will be shown in the display.

The phone number must have at least three and maximum 13 digits in order for an announcement to be attached.

Make a test recording to find the best speech intensity and distance to the microphone.

Note!

Remember to enter the area code when you store a phone number in the Phonebook. Otherwise Voice Announcement will not function.

Entering phone numbers and recording names into the Phonebook

Press

The next free index number is shown

Enter the phone number (including area code)

Press **Ⓟ** to start recording

The display shows the time available

Record the name

*-----
The line in the display counts down the available recording time for the Voice Announcement*

Press **Ⓟ** to end the recording

Continue with this procedure until you have entered and recorded the numbers and names desired – up to 50.

The numbers and names are stored in the order in which they were entered and recorded.

It is, however, technically possible to record up to 75 names, but this will reduce the time for announcements and messages to 13 minutes. With 50 names in the Phonebook the time available is 15 minutes.

The first number is shown with index number 1, the next one with index number 2...

If the phone number has more than 10 digits, the index number will not be shown

Activating/deactivating the Voice Announcement Phonebook

In connection with the entering of numbers and recording of names into the Phonebook, the Phonebook will be activated automatically. If the Phonebook is deactivated, the name will not be stated when a call is received, but the number will still be shown in the display.

Playing and editing the Phonebook

It is possible to play the names recorded in the Phonebook at the same time as the relevant phone number is shown in the display.

Moreover, it is possible to delete names and phone numbers in the Phonebook.

If a new name is recorded for an already entered phone number, the old name will be automatically deleted.

Activating Phonebook

Press until is shown constantly in the display

The Phonebook is activated

Deactivating Phonebook

Press until flashes in the display

The Phonebook is deactivated

Playing and editing the Phonebook

Press

The next free index number is shown

Press < or > to play the list

The latest number entered in the Phonebook is shown in the display at the same time as the name recorded is stated

Press C to delete the number shown and the name

- - - is shown in the display

or

Enter a new phone number for a name played

Enter the new phone number

Press OK

or

Record a new name for a number displayed

Press to record a new name

Record the name

Press to end the recording

The display shows the time available:- - - - -

Transferring phone numbers from the News list to the Phonebook

Recording announcements for no Caller ID and for phone numbers which are not in the Phonebook

In some cases the Caller ID function is not possible. Here the telephone company will send information codes which will be shown in the display in the following ways:

- 0 in cases of technical limitations
- 1 when a call is from a restricted number
- 2 when no number has been transferred

You can record a "name" for each of these codes so that the Phonebook will state them when these codes are sent.

Please note that the "name" you have recorded together with code -0 is also the "name" that will be played if you receive a call from a phone number which you have not already stored and recorded in the Phonebook. This may be an advantage as you will hear the announcement instead of three brief tones.

BeoTalk 1200 cannot always be expected to register calls from cellular phones if the calls are made from abroad.

Transferring phone numbers from the News list

Press **!!!** until the number desired is shown in the display *The playing starts*

or

Press **!!!**
Press **<** or **>** until the number desired is shown in the display

then...

Press
Press **Ⓟ** to start the recording

The display shows the time available: -----

Record the name

Press **Ⓟ** to end the recording

Recording of announcements when Caller ID is not possible

Press
Press e.g. 2
Press **Ⓟ**
Record e.g. "Not possible"
Press **Ⓟ**

Rejection of incoming calls

If you do not want to receive calls from certain phone numbers, you can enter these numbers in the Rejection list and thus make BeoTalk 1200 reject the calls. You may also transfer a number from the News list or the Phonebook to the Rejection list.

BeoTalk 1200 answers the calls immediately after the phone starts ringing, independently of the ringing time that you have entered.

The call will be answered by a busy tone. The phone number of the incoming call will be transferred to the News list.

BeoTalk 1200 gives higher priority to Rejection than to Group Announcement. This means that a call from the number will be rejected if the same number exists in both lists.

Note!

Remember to enter the area code when you store a phone number in the Rejection list.

Entering phone numbers to be rejected

Press **X**

If the list is empty, – is shown together with index number 1

Enter the first phone number
Press **OK**

The numbers are stored in the same order as they are entered.

Enter the second phone number
Press **OK**

The number that is entered first is shown with index number 1, the next number with index number 2...

Continue this process until the numbers desired have been entered, maximum 10

If the phone number has more than 10 digits the index number will not be shown

Transferring phone numbers from the News list or the Phonebook

Press **!!!** until the number desired is shown in the display

Press **X**
Press **OK** to store

X and the phone number selected are shown in the display

or
Press **□**
Press **<** or **>** until the number desired is shown in the display

Press **X**
Press **OK** to store

X and the phone number selected are shown in the display

The list can be edited in the same way as the phone number list for Group Announcement, see page 29.

Scrolling through the Rejection list

Press **X**

The last entered number in the list is shown in the display followed by an index number 1-10

Press **<** or **>** to search in the list

Activating the Rejection function

Press **X**

***X** is shown in the display*

When you use Rejection of calls the answering machine function must be activated

Deactivating the Rejection function

Press **X** until the symbol flashes in the display

Group Announcement

The phone numbers to be answered by a Group Announcement must be entered in the Group Announcement list. Group Announcement can only be activated if an announcement has been recorded and minimum one phone number has been entered.

Remember to enter the area code when you enter a phone number.

If the Group Announcement list is full, the phone number and index number will flash in the display. An existing number must be deleted before a new number can be added.

To use the Group Announcement function you also need to have recorded and activated either Announcement Only or Announcement and Message. People whose phone numbers are not stored in the Group Announcement list will then hear that other announcement.

Recording an announcement

Press **Ⓜ**
Press **Ⓜ**

Record an announcement
Press **Ⓜ**

Ⓜ is shown in the display
Ⓜ is shown in the display. The time function will count from 0:00
The announcement will be played back as a check and duration is shown

Entering phone numbers in the Group Announcement list

Press **Ⓜ**
Enter the first phone number
Press **OK** to store
Enter the second phone number
Press **OK** to store

Continue using this procedure until all the numbers desired have been entered (max. 30)

If the list is empty, the display will show – and index number 1.
The numbers will be stored in the order entered. The first number will be shown with index number 1, the next with index number 2...
If the phone number has more than 10 digits the index number will not be shown

Scrolling through the Group Announcement list

Press **Ⓜ**
Press **<** or **>** to search in the list

The latest number entered in the list is shown in the display followed by an index number 1-30

Activating Group Announcement

Press **Ⓜ** until **Ⓜ** is shown constantly in the display

Deactivating Group Announcement

Press **Ⓜ** until **Ⓜ** starts flashing in the display

Transferring phone numbers from the News list or the Phonebook to the Group Announcement list

Editing the phone numbers in the Group Announcement list or the Rejection list

Transferring phone numbers from the News list or the Phonebook

Press **!!!** until the number desired is shown in the display

Press **Ⓜ** *Ⓜ and the number chosen is shown in the display*

Press **OK** to store

or

Press **□**

Press **<** or **>** until the number desired is shown in the display

Press **Ⓜ** *Ⓜ and the number chosen is shown in the display*

Press **OK** to store

Editing while entering phone numbers

Press **<** or **>** to move the cursor

Press **C** to delete a digit

...after entering

Press **Ⓜ** or **×**

Press **<** or **>** to search in the list

The latest number entered in the list is shown in the display followed by an index number 1-30 (or 1-10).

Press **C** to delete the number shown

The display shows - - -

Enter new numbers, if relevant

Press **OK** to end editing

Volume

The volume in the loudspeaker can be adjusted in 8 steps. 1 is the lowest and 8 the highest volume.

The volume can be adjusted while the clock is shown in the display or while playing incoming messages or outgoing announcements.

Note!

The volume cannot be adjusted while you play outgoing announcements with Listening-in activated.

Adjusting the volume

Press **>** to increase the volume

Press **<** to decrease the volume

A broken line in the display shows the actual volume from 1 to 8

Ringling time

BeoTalk 1200 answers incoming calls after a ringing time of from 4 to 99 seconds. This function is programmable. The ringing time is pre-set to 15 seconds, corresponding to the telephone ringing 2-3 times.

Setting the ringling time

Press **△**

Enter the ringing time desired from **4** to **99** seconds

The actual ringing time is displayed

The new ringing time is displayed

While setting the ringing time...

Press **>** to move the cursor to the right

Press **<** to move the cursor to the left

Press **OK** to store

Remote control of BeoTalk 1200

PIN-code for remote control

To be able to remote control the answering machine from an external telephone, you must enter an access code of your own choice.

While the access code is being entered, it is shown in the display as a confirmation.

If you forget your access code, you just have to enter a new code.

Entering PIN-code

Press **0**

Enter a 4-figure code using the 0-9 keys

Press **OK** to store

- - - - is shown in the display

The code entered is shown in the display

Remote control of News

With the PIN-code you will get access to remote controlling your BeoTalk 1200.

While remote controlling it is possible to:

1. Play News
2. Activate the answering machine function
3. Record outgoing announcements

It is only necessary to store a message if you still want it to play as a "new message".

It is not necessary to delete News after playing them. BeoTalk 1200 automatically deletes the oldest messages when there is no memory left for new ones.

Note!

If the answering machine function has not been activated, up to one and a half minute will pass before BeoTalk 1200 answers the call.

Access to remote control

Call BeoTalk 1200

Wait until BeoTalk 1200 starts playing the announcement (max. 1½ minutes)

Press ✖

Enter the PIN-code

If the access code has been entered incorrectly or if BeoTalk 1200 will not accept it, press ✖ and the access code again

The announcement is interrupted and dialling tone becomes audible. Access signal for remote control becomes audible

Playing News

Press **5** to play News

While playing...

Press **5** to play the next News

Press **8** to store the News being played

Press **0** to delete the News being played

Press **⏏** to interrupt playing the News

BeoTalk 1200 starts playing the News list: Messages received and Internal messages will be played, Voice Announcements will be stated if the names have been recorded in the Phonebook. If you have not recorded any name in the Phonebook or a -0 "name" (see page 25), you will hear 3 brief tones.

Activating the answering machine

When the answering machine function has been activated remotely, it is only possible to deactivate the function locally on BeoTalk 1200.

Note!

BeoTalk 1200 cannot be remote controlled if it is being operated locally at the same time.

Activating the answering machine function from an external phone

Press **1** to activate Announcement Only *Announcement Only is played*

or

Press **2** to activate Announcement and Message *Announcement and Message is played*

Recording a new announcement from an external phone

Press **1** or **2** to choose
Announcement Only or
Announcement and Message

Press **3** to start recording an
announcement

Record an announcement

Press **3** to conclude recording

Cancel recording...

Press **#** while recording

Remote control of Internal messages

When remote controlling BeoTalk 1200 you may choose only to play Internal messages.

For example, Internal messages can be used for internal communication between members of the family.

Playing Internal messages

Press **4**

Playing of Internal messages starts

While playing...

Press **4** to play the next Internal message

Press **8** to store the message being played

Press **0** to delete the message being played

Press **#** to interrupt playing

Recording a new Internal message

Press **6**

Record a new message

Press **6** to conclude recording

Toll saver

The Toll saver function may save you the costs of a long-distance call when you remote control BeoTalk 1200 in order to play possible new messages.

If there are new messages, BeoTalk 1200 answers all calls after just one ringing tone, regardless of the ringing time you have entered.

If there are no new messages, the ringing time will correspond to the ringing time previously entered. You will then have time to replace the handset before BeoTalk 1200 starts answering the call.

Activating the Toll saver

Press **\$**

\$ is shown constantly in the display

Deactivating the Toll saver

Press **\$**

\$ flashes 4 times after which it is turned off

Symptom	Possible cause	Possible correction
The answering machine function cannot be activated	No announcement has been recorded for the type of announcement chosen	Record an announcement and activate the type of announcement
A new number is shown in the display, but you will hear only one ringing tone	<ul style="list-style-type: none"> • Rejection of incoming calls has been activated • The ringing time has been set to 4 seconds 	
Some subscribers cannot call you	The numbers exist in the Rejection list, and the function has been activated	
The display is illuminated though all messages have been played	There are further new messages (Caller ID calls or messages)	Scroll through the News list
 is shown in the display and the display is illuminated	<ul style="list-style-type: none"> • BeoTalk 1200 has not been connected to the telephone plug • A telephone is off-hook 	<ul style="list-style-type: none"> • Connect BeoTalk 1200 to the telephone plug • Replace the handset
BeoTalk 1200 answers the call sooner than the pre-programmed ringing time	New messages received and at the same time the Toll saver has been activated	
The phone rings more than one time when using Rejection of incoming calls	<ul style="list-style-type: none"> • Technical limitations • Rejection has not been activated 	
The index numbers are not shown in the display as described in this guide	The phone numbers have more than 10 digits	
BeoTalk 1200 continues to play the announcement after you have answered the call	BeoTalk 1200 has not registered that you have answered the call	<ul style="list-style-type: none"> • Replace the handset briefly <i>or</i> • Press the NEWS or STORE key on BeoTalk 1200

Symptom	Possible cause	Possible correction
The remote control does not work	<ul style="list-style-type: none"> • The PIN-code has not been entered • The telephone from which you call does not transmit tones • BeoTalk 1200 is being operated locally • The connection is poor 	<ul style="list-style-type: none"> • Enter the access code • Call from another telephone • Try call again later • Call from another telephone
BeoTalk 1200 is "dead"	BeoTalk 1200 has been incorrectly connected	Check the connection
A number called from a parallel telephone is not shown in the display	The telephone from which you call does not transmit DTMF tones	
The clock does not show the correct time	Power failure	Set the clock
While playing messages using remote control, BeoTalk 1200 executes commands you have not asked for	A message contains DTMF tones	<ul style="list-style-type: none"> • Press # and continue the operation, or • Replace the handset and call again
BeoTalk 1200 answers a Call-back	BeoTalk 1200 registers the call as an ordinary call	Deactive the answering machine function until the Call-back has been concluded
The telephone answering machine does not answer a phone call when ringing	<ul style="list-style-type: none"> • The telephone answering function has been deactivated • The ringing time is too long 	<ul style="list-style-type: none"> • Activate the answering machine function • Set the ringing time
It is not possible to record a new announcement	Memory is full	Press C to delete the old announcement (while playing the announcement)
Voice Announcement, Group Announcement and Rejection of incoming calls do not function	The complete telephone number, including area code, has not been stored in the list	Store the complete number (at least three and maximum 13 digits). Please note that in some regions you need not to enter the area code. This you will know by looking at the display seeing how the incoming phone numbers are shown. You must store your numbers in the same way

Capacity

Total speech time of 15 minutes for outgoing announcements, messages received and Internal messages. With 15 minutes' total speech time the Voice Announcement Phonebook has a capacity of 50 phone numbers and names. However, it is technically possible to record up to 75 names, but this will reduce the time available for announcements and messages to 13 minutes.

Memory

When pressing the **OK** button, the symbol  in the display shows how much of the memory has been used. The contents of the memory is the sum of outgoing announcements, new messages and names in the Phonebook.

The symbol for memory used is shown in 5 steps:

     where  indicates almost no memory used, and  almost the entire memory used.

When the entire memory has been filled,  flashes in the display. Play the

News list to gain more space. The memory for announcements, messages and phone number lists works independently of any power failure.

Automatic deletion of messages

BeoTalk 1200 automatically deletes all new messages played when more space is needed.

If the memory has been completely filled by new messages, BeoTalk 1200 switches automatically to playing Announcement Only. If no Announcement Only has been recorded, BeoTalk 1200 plays Announcement and Message followed by a series of tones.

You can gain more space by playing News.

Sound signals

BeoTalk 1200 transmits the following sound signals in connection with remote control and calls to the answering machine:

0 — 1 — 2 — 3 — 4 seconds

Caller ID without name

Three brief tones



Access tone to record a message

Unbroken tone



Memory almost full

Tone interrupted at very high tempo



Memory full

Tone interrupted at slow tempo



Access tone for remote control

Tone interrupted at very high tempo



Remote control command accepted

Tone interrupted at very high tempo



Remote control rejected

Tone interrupted at high tempo

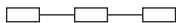

□ = sound signal

— = pause

FCC REGULATIONS

This equipment complies with part 68 of the Federal Communications Commission (FCC) rules for the United States.

A label is located on the underside of the unit containing the FCC registration number and Ringer Equivalence Number (REN). You must upon request, provide the following information to your local telephone company:

Facility Interface Code: N/A

REN 0,0B

Service Order Code: N/A

USOC Jack Type: RJ-11C

Should you experience trouble with this telephone equipment, please contact:

Bang & Olufsen America, Inc.
780 West Dundee Road
Arlington Heights, IL 60004

The REN is used to determine the quantity of devices which may be connected to the telephone line. Excessive RENs on the telephone line may result in the devices not ringing in response to an incoming call. In most, but not all areas, the sum of RENs should not exceed five (5.0). To be certain of the number of devices that may be connected to a line, as determined by the total RENs contact your local telephone company.

If trouble is experienced with this BeoTalk 1200, for repair or warranty information, please contact Bang & Olufsen of America. If the equipment is causing harm to the telephone network, the telephone company may request that you disconnect the equipment until the problem is resolved. For repair/warranty information, the telephone company may ask you to disconnect this equipment from the line network until the problem has been corrected.

This equipment cannot be used on public coin phone service provided by the telephone company. Connection to party line service is subject to state tariffs. Your telephone company may discontinue your service if your equipment causes harm to the telephone network. They will notify you in advance of disconnection, if possible. During notification, you will be informed of your right to file a complaint to the FCC. Occasionally, your telephone company may make changes in its facilities, equipment, operation, or procedures that could affect the operation of your telephone answering machine. If so, you will be given advance notice of the change to give you an opportunity to maintain uninterrupted service.

Cleaning

Clean your BeoTalk 1200 using a soft cloth dipped in water containing a few drops of a mild detergent.

Data

Network

Analog (PSTN)

Power supply

Netadaptor 120 V AC / 9 V DC

Ambient temperature

+41°F - +131°F

5°C - 55°C

Relative humidity

15% - 95%

Industry Canada Warnings

NOTICE: The Industry Canada Label identifies certified equipment. This certification means that the equipment meets telecommunications network protective, operational and safety requirements as prescribed in the appropriate Terminal Equipment Technical Requirements document(s). The Department does not guarantee the equipment will operate to the user's satisfaction.

Before installing this equipment, users should ensure that it is permissible to be connected to the facilities of the local telecommunications company. The equipment must also be installed using an acceptable method of connection. The customer should be aware that compliance with the above conditions may not prevent degradation of service in some situations. Repairs to certified equipment should be coordinated by a representative designated by the supplier. Any repairs or alterations made by the user to this equipment, or equipment malfunctions, may give the telecommunications company cause to request the user to disconnect the equipment.

Users should ensure for their own protection that the electrical ground connections of the power utility, telephone lines and internal metallic water pipe system, if present, are connected together. This precaution may be particularly important in rural areas.

Caution: Users should not attempt to make such connections themselves, but should contact the appropriate electric inspection authority, or electrician, as appropriate.

NOTICE: The Ringer Equivalence Number (REN) assigned to each terminal device provides an indication of the maximum number of terminals allowed to be connected to a telephone interface. The termination on an interface may consist of any combination of devices subject only to the requirement that the sum of the Ringer Equivalence Number of all the devices does not exceed 5.

Cleaning

Clean your BeoTalk 1200 using a soft cloth dipped in water containing a few drops of a mild detergent.

Data

Network
Analog (PSTN)

Power supply
Netadaptor 120 V AC / 9 V DC

Ambient temperature
5°C – 55°C

Relative humidity
15% – 95%



350708802070000